

HAMEG

Instruments

MANUAL

**Oscilloscope
HM604-3**

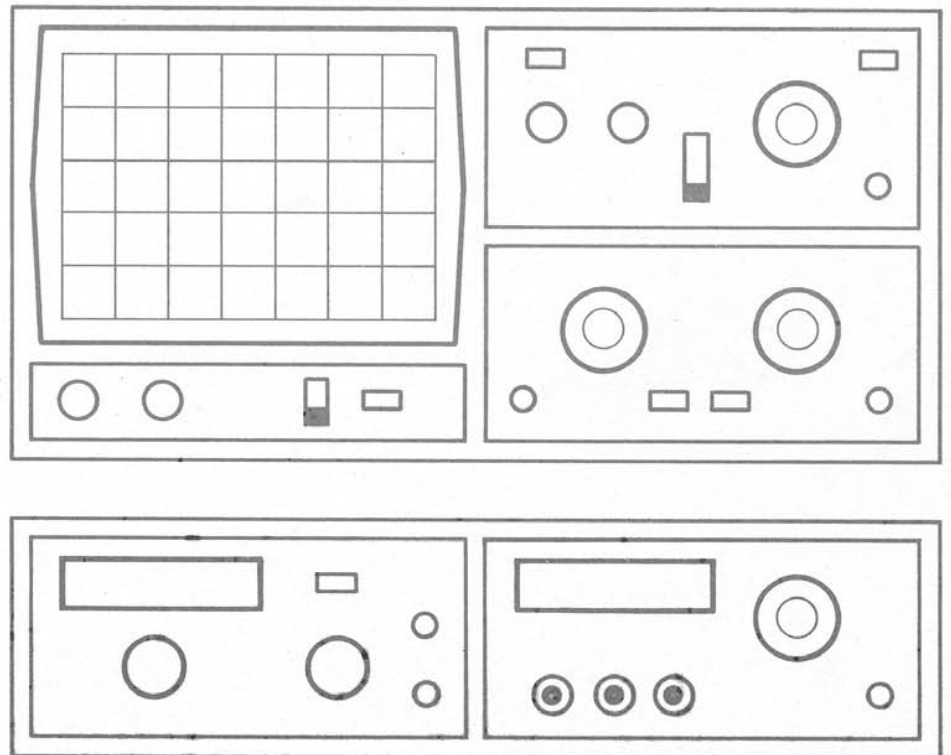

Oscilloscope data sheet with technical details 4

Operating Instructions

General Information 5
 Symbols 5
 Use of tilt handle 5
 Safety 5
 Operating conditions 5
 EMC 6
 Warranty 6
 Maintenance 6
 Protective Switch-Off 6
 Power supply 6
 Type of signal voltage 7
 Amplitude Measurements 7
 Total value of input voltage 8
 Time Measurements 8
 Connection of Test Signal 9
 First Time Operation 10
 Trace Rotation TR 10
 Probe compensation and use 11
 Adjustment at 1kHz 11
 Adjustment at 1MHz 11
 Operating modes of the vertical amplifiers in Yt mode. 12
 X-Y Operation 12
 Phase comparison with Lissajous figures 13
 Phase difference measurement in DUAL mode 13
 Measurement of an amplitude modulation 13
 Triggering and time base 14
 Automatic Peak-Triggering 14
 Normal Triggering 15
 Slope 15
 Trigger coupling 15
 Line triggering (-) 16
 Alternate triggering 16
 External triggering 16
 Trigger indicator 16
 Holdoff-time adjustment 16
 Delay / After Delay Triggering 17
 AUTO SET 18
 SAVE/RECALL 19
 Component Tester 19
 Using the Component Tester 19
 Test Procedure 19
 Test Pattern Displays 19
 Testing Resistors 20
 Testing Capacitors and Inductors 20
 Testing Semiconductors 20
 Testing Diodes 20
 Testing Transistors 20
 In-Circuit Tests 20

Oscilloscope HM604-3

Test Instructions

General 23
 Astigmatism Check 23
 Symmetry and Drift of the Vertical Amplifier 23
 Calibration of the Vertical Amplifier 23
 Transmission Performance of the Vertical Amplifier 23
 Triggering Checks 24
 Timebase 24
 Holdoff time 25
 Component Tester 25
 Trace Alignment 25

Service Instructions

General 25
 Instrument Case Removal 25
 Operating Voltages 26
 Maximum and Minimum Brightness 26
 Astigmatism control 26
 Trigger Threshold 26
 Trouble-Shooting the Instrument 26
 Adjustments 26
 RS232 Interface - Remote Control 27
 Baud-Rate Setting 27
 Data Communication 27
 Command definition 27
 Command Chart: 27
 Instrument Data Field with Single Commands 28
 Short instruction for HM304 29
 Switching on and initial setting 29
 Vertical amplifier mode 29
 Triggering mode 29
 Measurements 29
 Component tester mode 29
 Front Panel Elements HM604-3 (Brief Description - Front View) 30

St.1196-Hüb/R0s

General information regarding the CE marking

HAMEG instruments fulfill the regulations of the EMC directive. The conformity test made by HAMEG is based on the actual generic- and product standards. In cases where different limit values are applicable, HAMEG applies the severer standard. For emission the limits for residential, commercial and light industry are applied. Regarding the immunity (susceptibility) the limits for industrial environment have been used.

The measuring- and data lines of the instrument have much influence on emission and immunity and therefore on meeting the acceptance limits. For different applications the lines and/or cables used may be different. For measurement operation the following hints and conditions regarding emission and immunity should be observed:

1. Data cables

For the connection between instruments resp. their interfaces and external devices, (computer, printer etc.) sufficiently screened cables must be used. Without a special instruction in the manual for a reduced cable length, the maximum cable length of a dataline must be less than 3 meters long. If an interface has several connectors only one connector must have a connection to a cable.

Basically interconnections must have a double screening. For IEEE-bus purposes the double screened cables HZ72S and HZ72L from HAMEG are suitable.

2. Signal cables

Basically test leads for signal interconnection between test point and instrument should be as short as possible. Without instruction in the manual for a shorter length, signal lines must be less than 3 meters long.

Signal lines must be screened (coaxial cable - RG58/U). A proper ground connection is required. In combination with signal generators double screened cables (RG223/U, RG214/U) must be used.

3. Influence on measuring instruments.

Under the presence of strong high frequency electric or magnetic fields, even with careful setup of the measuring equipment an influence of such signals is unavoidable.

This will not cause damage or put the instrument out of operation. Small deviations of the measuring value (reading) exceeding the instruments specifications may result from such conditions in individual cases.

December 1995

HAMEG GmbH

**KONFORMITÄTSERKLÄRUNG
DECLARATION OF CONFORMITY
DECLARATION DE CONFORMITE**



HAMEG[®]
Instruments

Name und Adresse des Herstellers
Manufacturer's name and address
Nom et adresse du fabricant

HAMEG GmbH
Kelsterbacherstraße 15-19
D - 60528 Frankfurt

HAMEG S.a.r.l.
5, av de la République
F - 94800 Villejuif

Die HAMEG GmbH / HAMEG S.a.r.l. bescheinigt die Konformität für das Produkt
The HAMEG GmbH / HAMEG S.a.r.l. herewith declares conformity of the product
HAMEG GmbH / HAMEG S.a.r.l. déclare la conformité du produit

Bezeichnung / Product name / Designation: Oszilloskop/Oscilloscope/Oscilloscope

Typ / Type / Type: **HM604-3**

mit / with / avec: -

Optionen / Options / Options: -

mit den folgenden Bestimmungen / with applicable regulations / avec les directives suivantes

EMV Richtlinie 89/336/EWG ergänzt durch 91/263/EWG, 92/31/EWG
EMC Directive 89/336/EEC amended by 91/263/EWG, 92/31/EEC
Directive EMC 89/336/CEE amendée par 91/263/EWG, 92/31/CEE

Niederspannungsrichtlinie 73/23/EWG ergänzt durch 93/68/EWG
Low-Voltage Equipment Directive 73/23/EEC amended by 93/68/EEC
Directive des équipements basse tension 73/23/CEE amendée par 93/68/CEE

Angewendete harmonisierte Normen / Harmonized standards applied / Normes harmonisées utilisées

Sicherheit / Safety / Sécurité

EN 61010-1: 1993 / IEC (CEI) 1010-1: 1990 A 1: 1992 / VDE 0411: 1994
Überspannungskategorie / Overvoltage category / Catégorie de surtension: II
Verschmutzungsgrad / Degree of pollution / Degré de pollution: 2

Elektromagnetische Verträglichkeit / Electromagnetic compatibility / Compatibilité électromagnétique

EN 50082-2: 1995 / VDE 0839 T82-2
ENV 50140: 1993 / IEC (CEI) 1004-4-3: 1995 / VDE 0847 T3
ENV 50141: 1993 / IEC (CEI) 1000-4-6 / VDE 0843 / 6
EN 61000-4-2: 1995 / IEC (CEI) 1000-4-2: 1995 / VDE 0847 T4-2: Prüfschärfe / Level / Niveau = 2

EN 61000-4-4: 1995 / IEC (CEI) 1000-4-4: 1995 / VDE 0847 T4-4: Prüfschärfe / Level / Niveau = 3

EN 50081-1: 1992 / EN 55011: 1991 / CISPR11: 1991 / VDE0875 T11: 1992
Gruppe / group / groupe = 1, Klasse / Class / Classe = B

Datum /Date /Date

14.12.1995

Unterschrift / Signature /Signatur

Dr. J. Herzog
Technical Manager
Directeur Technique

Specifications

Vertical Deflection

Operating modes: Channel I or II separate, Channel I and II: alternate or chopped. (0.5MHz chopper frequency, approx.)
Sum or difference with Ch. I and Ch. II (both channels invertable).
XY-Mode: via channel I and channel II
Frequency range: 2xDC to 60MHz (-3dB)
 Risetime: <5.9ns. Overshoot max. 1%.
Deflection coefficients: 14 calibrated steps from 1mV/div. to 20V/div. (1-2-5 sequence) with variable 2.5:1 up to 50V/div.
Accuracy in calibrated position:
 1mV/div. to 2mV/div.: ±5% (0 to 10MHz (-3dB))
 5mV/div. to 20V/div.: ±3%
Input impedance: 1MΩ || 20pF.
 Input coupling: DC-AC-GD (ground).
 Input voltage: max. 400V (DC + peak AC).
Delay line: approx. 90ns

Triggering

Automatic: (peak to peak) <20Hz-100MHz (≤0.5div.)
 Normal with level control: DC-100MHz (≤0.5div.)
Slope: positive or negative,
ALT. Triggering: LED indicator for trigger action
Sources: Channel I or II, CH. I alternating CH II, line and external
 Coupling: AC (10Hz to 100MHz), DC (0 to 100MHz), HF (1.5kHz to 100MHz), LF (0 to 1.5kHz)
Active TV-Sync-Separator (pos. and neg.)
External: ≥0.3V_{pp} from DC to 60MHz
2nd triggering (Del. Trig.): normal with level control DC to 100 MHz

Horizontal Deflection

Time coefficients: 22 calibrated steps from 0.5s/div. to 50ns/div. in 1-2-5 sequence
 Accuracy in calibrated position: ±3%.
 variable 2.5:1 up to 1.25s/div.,
 with X-Mag. x10: 5ns/div. ±5%
Holdoff time: variable to approx. 10:1
Delay: 50ms - 100ns, variable 6:1 up to 300ms
Bandwidth X-amplifier: 0-3MHz (-3dB).
 Input X-Amplifier via Channel II,
 (sensitivity see Channel II specification)
 X-Y phase shift: <3° below 120KHz.

Operation / Control

Auto Set (automatic parameter selection)
Manual (Front Panel switches)
Memory for 6 user-defined parameter settings
Remote control with built-in RS-232 interface

Component Tester

Test voltage: approx. 8.5V_{rms} (open circuit).
 Test current: approx. 7mA_{rms} (shorted).
Test frequency: approx. 50Hz
 Test connection: 2 banana jacks 4mmØ
 One test lead is grounded (Safety Earth)

General Information

CRT: D14-372GH, rectangular screen (8x10div.) internal graticule
Acceleration voltage: approx 14kV
Trace rotation: adjustable on front panel
Calibrator: square-wave generator (t_r <4ns) ≈1kHz/1MHz; Output: 0.2V ±1% and 2V
Line voltage: 100-240V AC ±10%, 50/60Hz
Power consumption: approx. 40 Watt at 50Hz.
 Min./Max. ambient temperature: -10°C...+40°C
Protective system: Safety class I (IEC1010-1)
 Weight: approx. 5.6kg (12.4lbs), color: techno-brown
 Cabinet: W 285, H 125, D 380 mm (11.1x4.9x14.8 inches)
 Lockable tilt handle

Subject to change without notice.

10/95

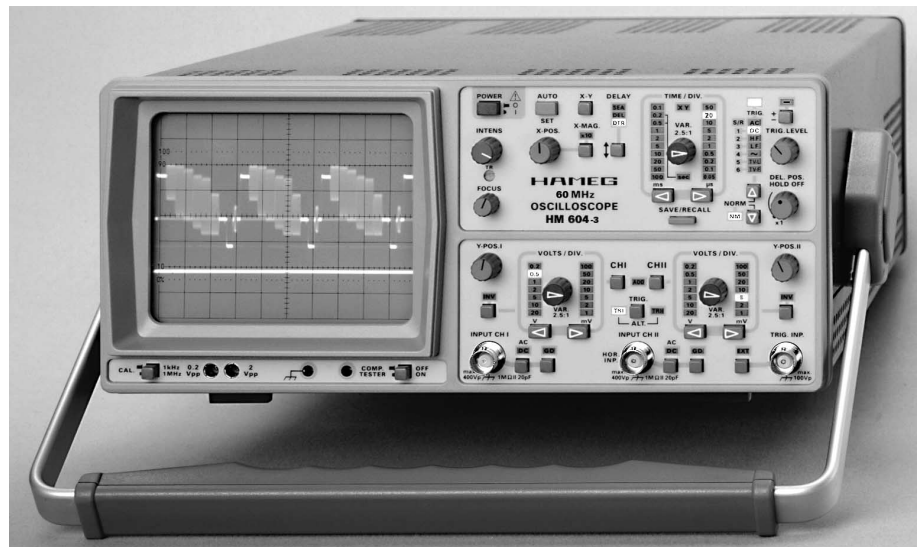

60MHz Multi-Function Oscilloscope HM 604-3

with Auto-Set, Save and Recall (6 Setup Memories)

Remote control via built-in RS-232 Interface

Vertical: 2 Channels, 1 mV/div. - 20 V/div., Comp.-Tester, 1MHz Calibrator

Time Base: 0.5 s/div. to 5 ns/div.; Trigger-after-delay; Alternate Trigger

Triggering: DC to 100 MHz; Automatic Peak to Peak; TV-Sync-Separator

The HM604-3 is HAMEG's 60 MHz microprocessor controlled analog oscilloscope. The internal microprocessor has the capability of automatically configuring the oscilloscope parameters, when used in the "Auto Set" mode, so as to present a display of three cycles of the input signal, with all of the proper control settings automatically configured: a single trace will be displayed with 4 to 6 divisions amplitude, while each signal will be 3 to 4 divisions high in dual trace mode. At a touch of the controls, the user can over-ride the automatic settings. Manual control is simple with easy to see indicators denoting uncalibrated operation by blinking. Switch/parameter settings are easily visible as bright LED scale value indications.

One powerful feature is the ability to store user-defined test scenarios, that can be called up on demand for repeated measurement tasks. A total of 6 setups can be saved and recalled as many times as required. Additional setup information is possible via the RS-232 port, which can be controlled from the serial port of a PC.

Although the instrument's vertical bandwidth is specified as 60 MHz, signals to 100 MHz can be displayed and triggered. Signal expansion up to a factor of 1,000 times can be obtained in the "Delay" and "Trigger after Delay" modes. A switching mode power supply minimises power and results in a lightweight unit weighing only 12.4 pounds (5.6kg).

The scope is ideal for fast troubleshooting. The Auto Set feature permits the rapid inspection of test points, without the need to constantly adjust the scope for each new test mode. The ability to Save/Recall facilitates the use of this unit for final inspections, where multiple, repeated scope settings are required. These capabilities result in labor saving operations which translate to more efficiency and cost savings to the customer.



Accessories supplied: Line Cord, Operators Manual, 2 Probes 10:1

General Information

This oscilloscope is easy to operate. The logical arrangement of the controls allows anyone to quickly become familiar with the operation of the instrument, however, experienced users are also advised to read through these instructions so that all functions are understood.

Immediately after unpacking, the instrument should be checked for mechanical damage and loose parts in the interior. If there is transport damage, the supplier must be informed immediately. The instrument must then not be put into operation.

Symbols

-  ATTENTION - refer to manual
-  Danger - High voltage
-  Protective ground (earth) terminal

Use of tilt handle

To view the screen from the best angle, there are three different positions (C, D, E) for setting up the instrument. If the instrument is set down on the floor after being carried, the handle automatically remains in the upright carrying position (A).

In order to place the instrument onto a horizontal surface, the handle should be turned to the upper side of the oscilloscope (C). For the D position (10° inclination), the handle should be turned to the opposite direction of the carrying position until it locks in place automatically underneath the instrument. For the E position (20° inclination), the handle should be pulled to release it from the D position and swing backwards until it locks once more.

The handle may also be set to a position for horizontal carrying by turning it to the upper side to lock in the B position. At the same time, the instrument must be lifted, because otherwise the handle will jump back.

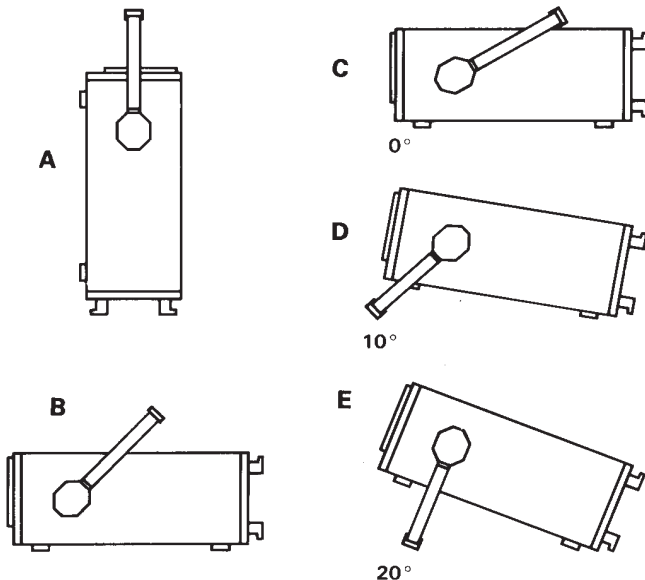

Safety

This instrument has been designed and tested in accordance with IEC Publication 1010-1 (overvoltage category II, pollution degree 2), Safety requirements for electrical equipment for measurement, control, and laboratory use. The CENELEC regulations EN 61010-1 correspond to this standard. It has left the factory in a safe condition. This instruction manual

contains important information and warnings which have to be followed by the user to ensure safe operation and to retain the oscilloscope in a safe condition.

The case, chassis and all measuring terminals are connected to the protective earth contact of the appliance inlet. The instrument operates according to Safety Class I (three-conductor power cord with protective earthing conductor and a plug with earthing contact).

The mains/line plug shall only be inserted in a socket outlet provided with a protective earth contact. The protective action must not be negated by the use of an extension cord without a protective conductor.

The mains/line plug should be inserted before connections are made to measuring circuits.

The grounded accessible metal parts (case, sockets, jacks) and the mains/line supply contacts (line/live, neutral) of the instrument have been tested against insulation breakdown with 2200V DC.

Under certain conditions, 50Hz or 60Hz hum voltages can occur in the measuring circuit due to the interconnection with other mains/line powered equipment or instruments. This can be avoided by using an isolation transformer (Safety Class II) between the mains/line outlet and the power plug of the device being investigated.

Most cathode-ray tubes develop X-rays. **However, the dose equivalent rate falls far below the maximum permissible value of 36pA/kg (0.5mR/h).**

Whenever it is likely that protection has been impaired, the instrument shall be made inoperative and be secured against any unintended operation. The protection is likely to be impaired if, for example, the instrument

- shows visible damage,
- fails to perform the intended measurements,
- has been subjected to prolonged storage under unfavourable conditions (e.g. in the open or in moist environments),
- has been subject to severe transport stress (e.g. in poor packaging).

Operating conditions

The instrument has been designed for indoor use. The permissible ambient temperature range during operation is +10°C (+50°F) ... +40°C (+104°F). It may occasionally be subjected to temperatures between +10°C (+50°F) and -10°C (+14°F) without degrading its safety. The permissible ambient temperature range for storage or transportation is -40°C (-40°F) ... +70°C (+158°F).

The maximum operating altitude is up to 2200m (non-operating 15000m). The maximum relative humidity is up to 80%.

If condensed water exists in the instrument it should be acclimatized before switching on. In some cases (e.g. extremely cold oscilloscope) two hours should be allowed before the instrument is put into operation. The instrument should be kept in a clean and dry room and must not be operated in explosive, corrosive, dusty, or moist environments. The oscilloscope can be operated in any position, but the convection cooling must not be impaired. The ventilation holes may not be covered. For continuous

operation the instrument should be used in the horizontal position, preferably tilted upwards, resting on the tilt handle.

The specifications stating tolerances are only valid if the instrument has warmed up for 30minutes at an ambient temperature between +15°C (+59°F) and +30°C (+86°F). Values without tolerances are typical for an average instrument.

EMC

This instrument conforms to the European standards regarding the electromagnetic compatibility. The applied standards are: Generic immunity standard EN50082-2:1995 (for industrial environment) Generic emission standard EN50081-1:1992 (for residential, commercial und light industry environment).

This means that the instrument has been tested to the highest standards.

Please note that under the influence of strong electromagnetic fields, such signals may be superimposed on the measured signals. Under certain conditions this is unavoidable due to the instrument's high input sensitivity, high input impedance and bandwidth. Shielded measuring cables, shielding and earthing of the device under test may reduce or eliminate those effect's.

Warranty

HAMEG warrants to its Customers that the products it manufactures and sells will be free from defects in materials and workmanship **for a period of 2 years**. This warranty shall not apply to any defect, failure or damage caused by improper use or inadequate maintenance and care. HAMEG shall not be obliged to provide service under this warranty to repair damage resulting from attempts by personnel other than HAMEG representatives to install, repair, service or modify these products.

In order to obtain service under this warranty, Customers must contact and notify the distributor who has sold the product.

Each instrument is subjected to a quality test with 10 hour burn-in before leaving the production. Practically all early failures are detected by this method. In the case of shipments by post, rail or carrier it is recommended that the original packing is carefully preserved. Transport damages and damage due to gross negligence are not covered by the guarantee.

In the case of a complaint, a label should be attached to the housing of the instrument which describes briefly the faults observed. If at the same time the name and telephone number (dialing code and telephone or direct number or department designation) is stated for possible queries, this helps towards speeding up the processing of guarantee claims.

Maintenance

Various important properties of the oscilloscope should be carefully checked at certain intervals. Only in this way is it largely certain that all signals are displayed with the accuracy on which the technical data are based. The test methods described in the test plan of this manual can be performed without great expenditure on measuring instruments. However, purchase of the **HAMEG scope tester HZ 60**, which despite its low price is highly suitable for tasks of this type, is very much recommended.

The exterior of the oscilloscope should be cleaned regularly with a dusting brush. Dirt which is difficult to remove on the casing and handle, the plastic and aluminium parts, can be

removed with a moistened cloth (99% water +1% mild detergent). Spirit or washing benzine (petroleum ether) can be used to remove greasy dirt. The screen may be cleaned with water or washing benzine (but not with spirit (alcohol) or solvents), it must then be wiped with a dry clean lint-free cloth. Under no circumstances may the cleaning fluid get into the instrument. The use of other cleaning agents can attack the plastic and paint surfaces.

Protective Switch-Off

This instrument is equipped with a switch mode power supply. It has both overvoltage and overload protection, which will cause the switch mode supply to limit power consumption to a minimum.

In this case a ticking noise may be heard.

Power supply

The oscilloscope operates on mains/line voltages between 100VAC and 240VAC. No means of switching to different input voltages has therefore been provided.

The power input fuses are externally accessible. The fuseholder is located above the 3-pole power connector.

The power input fuses are externally accessible, if the rubber conector is removed. The fuseholder can be released by pressing its plastic retainers with the aid of a small screwdriver. The retainers are located on the right and left side of the holder and must be pressed towards the center. The fuse(s) can then be replaced and pressed in until locked on both sides.

Use of patched fuses or short-circuiting of the fuseholder is not permissible; HAMEG assumes no liability whatsoever for any damage caused as a result, and all warranty claims become null and void.

Fuse type:

**Size 5x20mm; 0.8A, 250V AC fuse; must meet IEC specification 127, Sheet III (or DIN 41 662 or DIN 41 571, sheet 3).
Time characteristic: time-lag (T).**

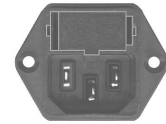

Attention!

There is a fuse located inside the instrument within the switch mode power supply:

**Size 5x20mm; 0.5A, 250V AC fuse; must meet IEC specification 127, Sheet III (or DIN 41 662 or DIN 41 571, sheet 3).
Time characteristic: fast (F).**

This fuse must not be replaced by the operator!

Type of signal voltage

With the HM604-3, most repetitive **signals in the frequency range up to at least 60MHz (-3dB)** can be examined.

Sinewave signals of 100MHz are displayed with a height of approx. 50% (-6dB). However when examining square or pulse type waveforms, attention must be paid to the harmonic content of such signals. The repetition frequency (fundamental frequency) of the signal must therefore be significantly smaller than the upper limit frequency of the vertical amplifier.

Displaying composite signals can be difficult, especially if they contain no repetitive higher amplitude content which can be used for triggering. This is the case with bursts, for instance. To obtain a well-triggered display in this case, the assistance of the variable holdoff and/or delay function may be required. Television video signals are relatively easy to trigger using the built-in TV-Sync-Separator (TV).

For optional operation as a DC or AC voltage amplifier, the vertical amplifier input is provided with a DC/AC switch. The DC position should only be used with a series-connected attenuator probe or at very low frequencies or if the measurement of the DC voltage content of the signal is absolutely necessary.

When displaying very low frequency pulses, the flat tops may be sloping with AC coupling of the vertical amplifier (AC limit frequency approx. 1.6 Hz for 3dB). In this case, DC operation is preferred, provided the signal voltage is not superimposed on a too high DC level. Otherwise a capacitor of adequate capacitance must be connected to the input of the vertical amplifier with DC coupling. This capacitor must have a sufficiently high breakdown voltage rating. DC coupling is also recommended for the display of logic and pulse signals, especially if the pulse duty factor changes constantly. Otherwise the display will move upwards or downwards at each change. Pure direct voltages can only be measured with DC-coupling.

Amplitude Measurements

In general electrical engineering, alternating voltage data normally refers to effective values (rms = root-mean-square value). However, for signal magnitudes and voltage designations in oscilloscope measurements, the peak-to-peak voltage (Vpp) value is applied. The latter corresponds to the real potential difference between the most positive and most negative points of a signal waveform.

If a sinusoidal waveform, displayed on the oscilloscope screen, is to be converted into an effective (rms) value, the resulting peak-to-peak value must be divided by $2\sqrt{2} = 2.83$. Conversely, it should be observed that sinusoidal voltages indicated in Vrms (Veff) have 2.83 times the potential difference in Vpp. The relationship between the different voltage magnitudes can be seen from the following figure.

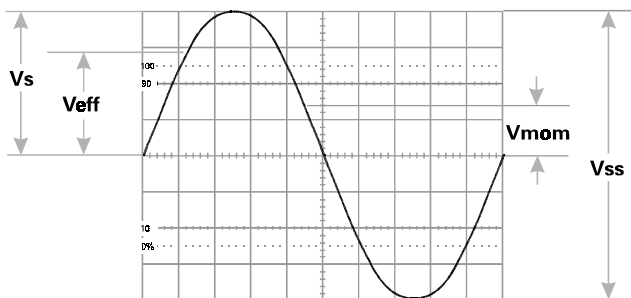

Voltage values of a sine curve

Vrms = effective value; Vp = simple peak or crest value;
Vpp = peak-to-peak value; Vmom = momentary value.

The minimum signal voltage which must be applied to the Y input for a trace of 1div. height is 1mVpp when the 1mV LED is lit and the vernier is set to CAL by turning the fine adjustment knob within the VOLTS/DIV. section fully clockwise. However, smaller signals than this may also be displayed. The deflection coefficients on the input attenuators are indicated in mV/div. or V/div. (peak-to-peak value).

The magnitude of the applied voltage is ascertained by multiplying the selected deflection coefficient by the vertical display height in div. If an attenuator probe x10 is used, a further multiplication by a factor of 10 is required to ascertain the correct voltage value.

For exact amplitude measurements, the variable control (VAR. 2.5:1) must be set to its calibrated detent CAL position. When turning the variable control ccw, the deflection coefficient LED will start to blink and the sensitivity will be reduced until a maximum factor of 2.5 is reached. Therefore any intermediate value is possible within the 1-2-5 sequence.

With direct connection to the vertical input, signals up to 400Vpp may be displayed (attenuator set to 20V/div., variable control to left stop).

With the designations

H = display height in div.,

U = signal voltage in Vpp at the vertical input,

D = deflection coefficient in V/div. at attenuator switch,

the required value can be calculated from the two given quantities:

$$U = D \cdot H \quad H = \frac{U}{D} \quad D = \frac{U}{H}$$

However, these three values are not freely selectable. They have to be within the following limits (trigger threshold, accuracy of reading):

H between 0.5 and 8div., if possible 3.2 to 8div.,

U between 1mVpp and 160Vpp,

D between 1mV/div. and 20V/div. in 1-2-5 sequence.

Examples:

Set deflection coefficient **D** = 50mV/div. \cong 0.05V/div.,
observed display height **H** = 4.6div.,
required voltage **U** = $0.05 \times 4.6 = 0.23$ Vpp.

Input voltage **U** = 5Vpp,
set deflection coefficient **D** = 1V/div.,
required display height **H** = $5:1 = 5$ div.

Signal voltage **U** = $230V_{rms} \times 2\sqrt{2} = 651$ Vpp
(voltage > 160Vpp, with probe 10:1: **U** = 65.1Vpp),
desired display height **H** = min. 3.2div., max. 8div.,
max. deflection coefficient **D** = $65.1:3.2 = 20.3$ V/div.,
min. deflection coefficient **D** = $65.1:8 = 8.1$ V/div.,
adjusted deflection coefficient **D** = 10V/div.

The input voltage must not exceed 400V, independent from the polarity.

If an AC voltage which is superimposed on a DC voltage is applied, the maximum peak value of both voltages must not exceed + or -400V. So for AC voltages with a mean value of zero volt the maximum peak to peak value is 800Vpp.

If attenuator probes with higher limits are used, the probes limits are valid only if the oscilloscope is set to

DC input coupling. If DC voltages are applied under AC input coupling conditions the oscilloscope maximum input voltage value remains 400V. The attenuator consists of a resistor in the probe and the 1MΩ input resistor of the oscilloscope, which are disabled by the AC input coupling capacity when AC coupling is selected. This also applies to DC voltages with superimposed AC voltages. It also must be noted that due to the capacitive resistance of the AC input coupling capacitor, the attenuation ratio depends on the signal frequency. For sinewave signals with frequencies higher than 40Hz this influence is negligible.

In the GD (ground coupling) setting, the signal path is interrupted directly beyond the input. This causes the attenuator to be disabled again, but now for both DC and AC voltages.

With the above listed exceptions HAMEG 10:1 probes can be used for DC measurements up to 600V or AC voltages (with a mean value of zero volt) of 1200Vpp. The 100:1 probe HZ53 allows for 1200V DC or 2400Vpp for AC.

It should be noted that its ACpeak value is derated at higher frequencies. If a normal x10 probe is used to measure high voltages there is the risk that the compensation trimmer bridging the attenuator series resistor will break down causing damage to the input of the oscilloscope. However, if for example only the residual ripple of a high voltage is to be displayed on the oscilloscope, a normal x10 probe is sufficient. In this case, an appropriate high voltage capacitor (approx. 22-68nF) must be connected in series with the input tip of the probe.

Total value of input voltage

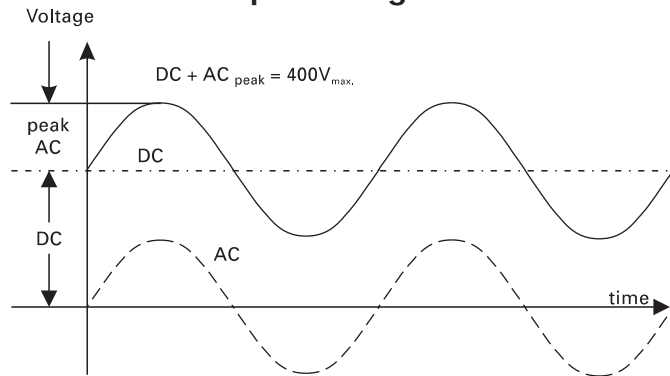

The dotted line shows a voltage alternating at zero volt level. If superimposed on a DC voltage, the addition of the positive peak and the DC voltage results in the max. voltage (DC + ACpeak).

With **Y-POS.** control (input coupling to **GD**) it is possible to use a **horizontal graticule line as reference line for ground potential before the measurement.** It can lie below or above the horizontal central line according to whether positive and/or negative deviations from the ground potential are to be measured.

Time Measurements

As a rule, most signals to be displayed are periodically repeating processes, also called periods. The number of periods per second is the repetition frequency. Depending on the time base setting indicated by one of the **TIME/DIV.** LED's, one or several signal periods or only a part of a period can be displayed. The time coefficients are stated in s/div. when the red sec-LED and the 0.5 or 0.2 LED (ms/div scale) are lit. The **ms/div.** or **μs/div.** time coefficients are indicated by one of the LED's on the ms or μs scale.

The duration of a signal period or a part of it is determined by multiplying the relevant time (horizontal distance in div.) by the time coefficient indicated on the TIME/DIV. LED scales.

The variable time control (identified with an arrow knob cap) must be in its calibrated position CAL. (arrow pointing horizontally to the right). For exact time measurements, the variable control (VAR. 2.5:1) must be set to its calibrated detent CAL position. When turning the variable control ccw, the time coefficient indicator LED starts blinking and the timebase speed will be reduced until a maximum factor of 2.5 is reached. Therefore any intermediate value is possible within the 1-2-5 sequence.

With the designations

L = displayed wave length in div. of one period,
T = time in seconds for one period,
F = recurrence frequency in Hz of the signal,
Tc = time coefficient in s/div. on timebase switch and the relation $F = 1/T$, the following equations can be stated:

$$T = L \cdot Tc \quad L = \frac{T}{Tc} \quad Tc = \frac{T}{L}$$

$$F = \frac{1}{L \cdot Tc} \quad L = \frac{1}{F \cdot Tc} \quad Tc = \frac{1}{L \cdot F}$$

With active X-MAG (x10) indicated by the x10 LED lit, the Tc value must be divided by 10.

However, these four values are not freely selectable. They have to be within the following limits:

- L** between 0.2 and 10div., if possible 4 to 10div.,
- T** between 0.01μs and 5s,
- F** between 0.5Hz and 35MHz,
- Tc** between 0.05μs/div. and 0.5s/div. in 1-2-5 sequence (with X-MAG. (x10) inactive), and
- Tc** between 5ns/div. and 20ms/div. in 1-2-5 sequence (with X-MAG. (x10) active).

Examples:

Displayed wavelength $L = 7\text{div.}$,
 set time coefficient $Tc = 0.1\mu\text{s/div.}$,
 required period $T = 7 \times 0.1 \times 10^{-6} = 0.7\mu\text{s}$
 required rec. freq. $F = 1:(0.7 \times 10^{-6}) = 1.428\text{MHz.}$

Signal period $T = 1\text{s}$,
 set time coefficient $Tc = 0.2\text{s/div.}$,
 required wavelength $L = 1:0.2 = 5\text{div.}$

Displayed ripple wavelength $L = 1\text{div.}$,
 set time coefficient $Tc = 10\text{ms/div.}$,
 required ripple freq. $F = 1:(1 \times 10 \times 10^{-3}) = 100\text{Hz.}$

TV-line frequency $F = 15625\text{Hz}$,
 set time coefficient $Tc = 10\mu\text{s/div.}$,
 required wavelength $L = 1:(15625 \times 10^{-5}) = 6.4\text{div.}$

Sine wavelength $L = \text{min. } 4\text{div.}, \text{ max. } 10\text{div.}$,
 Frequency $F = 1\text{kHz}$,
 max. time coefficient $Tc = 1:(4 \times 10^3) = 0.25\text{ms/div.}$,
 min. time coefficient $Tc = 1:(10 \times 10^3) = 0.1\text{ms/div.}$,
 set time coefficient $Tc = 0.2\text{ms/div.}$,
 required wavelength $L = 1:(10^3 \times 0.2 \times 10^{-3}) = 5\text{div.}$

Displayed wavelength $L = 0.8\text{div.}$,
 set time coefficient $T_c = 0.5\mu\text{s/div.}$,
 pressed X-MAG. (x10) button: $T_c = 0.05\mu\text{s/div.}$,
 required rec. freq. $F = 1:(0.8 \times 0.05 \times 10^{-6}) = 25\text{MHz}$,
 required period $T = 1:(25 \times 10^6) = 40\text{ns}$.

If the time is relatively short as compared with the complete signal period, an expanded time scale should always be applied (X-MAG. (x10) active). In this case, the ascertained time values have to be divided by 10. The time interval of interest can be shifted to the screen center using the X-POS. control.

When investigating pulse or square waveforms, the critical feature is the risetime of the voltage step. To ensure that transients, ramp-offs, and bandwidth limits do not unduly influence the measuring accuracy, the risetime is generally measured between 10% and 90% of the vertical pulse height. For measurement, adjust the Y deflection coefficient with its variable control together with the Y-POS. control so that the pulse height is precisely aligned with the 0% and 100% lines of the internal graticule. The 10% and 90% points of the signal will now coincide with the 10% and 90% graticule lines. The risetime is given by the product of the horizontal distance in div. between these two coincident points and the time coefficient setting. If X x10 magnification is used, this product must be divided by 10. The fall time of a pulse can also be measured by using this method.

The following figure shows correct positioning of the oscilloscope trace for accurate risetime measurement.

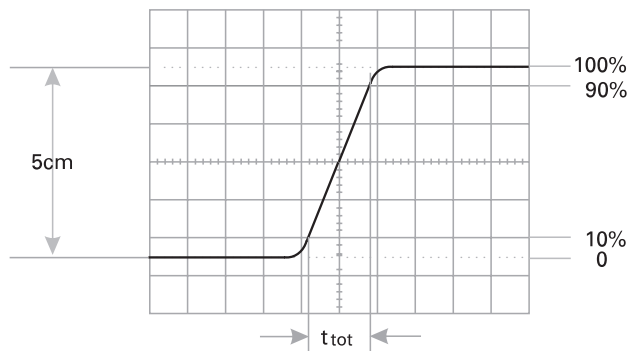

With a time coefficient of $0.05\mu\text{s/div.}$ and X x10 magnification, the example shown in the above figure results in a total measured risetime of

$$t_{\text{tot}} = 1.6\text{div} \times 0.05\mu\text{s/div.} : 10 = \mathbf{8\text{ns}}$$

When very fast risetimes are being measured, the risetimes of the oscilloscope amplifier and of the attenuator probe has to be deducted from the measured time value. The risetime of the signal can be calculated using the following formula.

$$t_r = \sqrt{t_{\text{tot}}^2 - t_{\text{osc}}^2 - t_p^2}$$

In this t_{tot} is the total measured risetime, t_{osc} is the risetime of the oscilloscope amplifier (approx. 12ns), and t_p the risetime of the probe (e.g. = 2ns). If t_{tot} is greater than 100ns, then t_{tot} can be taken as the risetime of the pulse, and calculation is unnecessary.

Calculation of the example in the figure above results in a signal risetime

$$t_r = \sqrt{8^2 - 5,8^2 - 2^2} = \mathbf{5,1\text{ns}}$$

The measurement of the rise or fall time is not limited to the trace dimensions shown in the above diagram. It is only

particularly simple in this way. In principle it is possible to measure in any display position and at any signal amplitude. It is only important that the full height of the signal edge of interest is visible in its full length at not too great steepness and that the horizontal distance at 10% and 90% of the amplitude is measured. If the edge shows rounding or overshooting, the 100% should not be related to the peak values but to the mean pulse heights. Breaks or peaks (glitches) next to the edge are also not taken into account. With very severe transient distortions, the rise and fall time measurement has little meaning. For amplifiers with approximately constant group delay (therefore good pulse transmission performance) the following numerical relationship between rise time t_r (in ns) and bandwidth B (in MHz) applies:

$$t_r = \frac{350}{B} \quad B = \frac{350}{t_r}$$

Connection of Test Signal

Caution: When connecting unknown signals to the oscilloscope input, always use automatic triggering and set the DC-AC input coupling switch to AC (DC not lit). The attenuator should initially be set to 20V/div.

Sometimes the trace will disappear after an input signal has been applied. The attenuator must be switched to a higher deflection coefficient by pressing the left (<) arrow pushbutton in the VOLTS/DIV. section constantly or step by step, until the vertical signal height is only 3-8div. With a signal amplitude greater than 160Vpp, an attenuator probe must be inserted before the vertical input. If, after applying the signal, the trace is nearly blanked, the period of the signal is probably substantially longer than the set value on the TIME/DIV. scale. It should be switched to an adequately larger time coefficient by pressing the left (<) arrow pushbutton in the TIME/DIV section by pressing it constantly or step by step. In most cases the easiest way to adapt the instruments settings to the input signal is to depress the AUTO SET pushbutton for automatic instrument settings.

The signal to be displayed can be connected directly to the Y-input of the oscilloscope with a shielded test cable such as HZ32 or HZ34, or reduced through a x10 or x100 attenuator probe. The use of test cables with high impedance circuits is only recommended for relatively low frequencies (up to approx. 50kHz). For higher frequencies, the signal source must be of low impedance, i.e. matched to the characteristic resistance of the cable (as a rule 50Ω). Especially when transmitting square and pulse signals, a resistor equal to the characteristic impedance of the cable must also be connected across the cable directly at the Y-input of the oscilloscope. When using a 50Ω cable such as the HZ34, a 50Ω through termination type HZ22 is available from HAMEG. When transmitting square signals with short rise times, transient phenomena on the edges and top of the signal may become visible if the correct termination is not used. A terminating resistance is sometimes recommended with sine signals as well. Certain amplifiers, generators or their attenuators maintain the nominal output voltage independent of frequency only if their connection cable is terminated with the prescribed resistance. Here it must be noted that the terminating resistor HZ22 will only dissipate a maximum of 2Watts. This power is reached with 10Vrms or at 28.3Vpp with sine signal.

If a x10 or x100 attenuator probe is used, no termination is necessary. In this case, the connecting cable is matched directly to the high impedance input of the oscilloscope. When using attenuators probes, even high internal impedance

sources are only slightly loaded (approx. $10M\Omega$ || $16pF$ or $100M\Omega$ || $9pF$ with HZ53). Therefore, if the voltage loss due to the attenuation of the probe can be compensated by a higher amplitude setting, the probe should always be used. The series impedance of the probe provides a certain amount of protection for the input of the vertical amplifier. Because of their separate manufacture, all attenuator probes are only partially compensated, therefore accurate compensation must be performed on the oscilloscope (see Probe compensation).

Standard attenuator probes on the oscilloscope normally reduce its bandwidth and increase the rise time. In all cases where the oscilloscope bandwidth must be fully utilized (e.g. for pulses with steep edges) we strongly advise using the probes HZ51 (x10) HZ52 (x10 HF) and HZ54 (x1 and x10). This can save the purchase of an oscilloscope with larger bandwidth.

The probes mentioned have a HF-calibration in addition to low frequency calibration adjustment. Thus a group delay correction to the upper limit frequency of the oscilloscope is possible with the aid of an 1MHz calibrator, e.g. HZ60.

In fact the bandwidth and rise time of the oscilloscope are not noticeably changed with these probe types and the waveform reproduction fidelity can even be improved because the probe can be matched to the oscilloscopes individual pulse response.

If a x10 or x100 attenuator probe is used, DC input coupling must always be used at voltages above 400V. With AC coupling of low frequency signals, the attenuation is no longer independent of frequency, pulses can show pulse tilts. Direct voltages are suppressed but load the oscilloscope input coupling capacitor concerned. Its voltage rating is max. 400 V (DC + peak AC). DC input coupling is therefore of quite special importance with a x100 attenuation probe which usually has a voltage rating of max. 1200 V (DC + peak AC). A capacitor of corresponding capacitance and voltage rating may be connected in series with the attenuator probe input for blocking DC voltage (e.g. for hum voltage measurement).

With all attenuator probes, **the maximum AC input voltage** must be derated with frequency usually above 20kHz. Therefore the derating curve of the attenuator probe type concerned must be taken into account.

The selection of the ground point on the test object is important when displaying small signal voltages. It should always be as close as possible to the measuring point. If this is not done, serious signal distortion may result from spurious currents through the ground leads or chassis parts. The ground leads on attenuator probes are also particularly critical. They should be as short and thick as possible. When the attenuator probe is connected to a BNC-socket, a BNC-adaptor, should be used. In this way ground and matching problems are eliminated. Hum or interference appearing in the measuring circuit (especially when a small deflection coefficient is used) is possibly caused by multiple grounding because equalizing currents can flow in the shielding of the test cables (voltage drop between the protective conductor connections, caused by external equipment connected to the mains/line, e.g. signal generators with interference protection capacitors).

First Time Operation

Switch on the oscilloscope by depressing the red POWER pushbutton. The instrument will revert to its last used operating mode. Except in the case of COMP. TESTER mode,

where a trace appears on the screen if the INTENS. knob is in center position, all LED's should remain unlit. The trace, displaying one baseline or the shorter COMP TESTER baseline, should be visible after a short warm-up period of approx. 10 seconds. If the COMP TESTER mode is active, depress the COMP TESTER pushbutton once to switch to XY or Yt mode. In XY mode the XY LED in the TIME/DIV section is lit, in this case depress the XY pushbutton once to switch over to Yt mode. Adjust Y-POS.I and X-POS. controls to center the baseline. Adjust INTENS. (intensity) and FOCUS controls for medium brightness and optimum sharpness of the trace. The oscilloscope is now ready for use.

- Rotate the variable controls with arrows, i.e. TIME/DIV. variable control, CH.I and CH.II attenuator variable controls, and HOLD OFF control to their calibrated detent.
- Set all controls with marker lines to their midrange position (marker lines pointing vertically).
- Depress the upper NORM. pushbutton until the AC symbol on the trigger coupling scale is lit.
- Both GD input coupling pushbutton switches for CH.I and CH.II in the Y-field should be set to the GD position (GD lit).

If only a spot appears (**CAUTION! CRT phosphor can be damaged**), reduce the intensity immediately and check that the XY mode is not selected (**XY LED** dark). If the trace is not visible, check the correct positions of all knobs and modes (particularly **NM LED** - normal triggering - LED on).

To obtain the maximum life from the cathode-ray tube, the minimum intensity setting necessary for the measurement in hand and the ambient light conditions should be used.

Particular care is required when a single spot is displayed, as a very high intensity setting may cause damage to the fluorescent screen of the CRT. Switching the oscilloscope off and on at short intervals stresses the cathode of the CRT and should therefore be avoided.

The instrument is so designed that even incorrect operation will not cause serious damage.

The HM604-3 accepts all signals from DC (direct voltage) up to a frequency of at least 60MHz (-3dB). For sinewave voltages the upper frequency limit will be 100MHz (-6dB). However, in this higher frequency range the vertical display height on the screen is limited to approx. 4-5div. The time resolution poses no problem. For example, with 100MHz and the fastest adjustable sweep rate (5ns/div.), one cycle will be displayed every 2div. The tolerance on indicated values amounts to $\pm 3\%$ in both deflection directions. All values to be measured can therefore be determined relatively accurately.

However, from approximately 10MHz upwards the measuring error will increase as a result of loss of gain. At 18MHz this reduction is about 10%. Thus, approximately 11% should be added to the measured voltage at this frequency. As the bandwidth of the amplifiers may differ slightly (normally between 60 and 78MHz), the measured values in the upper frequency range cannot be defined exactly. Additionally, as already mentioned, for frequencies above 60MHz the dynamic range of the display height steadily decreases. The vertical amplifier is designed so that the transmission performance is not affected by its own overshoot.

Trace Rotation TR

In spite of Mumetal-shielding of the CRT, effects of the earths magnetic field on the horizontal trace position cannot be completely avoided. This is dependent upon the orientation

of the oscilloscope on the place of work. A centred trace may not align exactly with the horizontal center line of the graticule. A few degrees of misalignment can be corrected by a potentiometer accessible through an opening on the front panel marked **TR**.

Probe compensation and use

To display an undistorted waveform on an oscilloscope, the probe must be matched to the individual input impedance of the vertical amplifier.

For this purpose a square wave signal with a very fast rise time and minimum overshoot should be used, as the sinusoidal contents cover a wide frequency range. The frequency accuracy and the pulse duty factor are not of such importance.

The built-in calibration generator provides a square wave signal with a very fast risetime (<4ns), and switch-selectable frequencies of approx. 1kHz and 1MHz from two output sockets below the CRT screen.

As the squarewave signals are used for probe compensation adjustments, neither the frequency accuracy nor the pulse duty factor are of importance and therefore not specified. One output provides 0.2Vpp \pm 1% (tr <4ns) for 10:1 probes, and the other 2Vpp for 100:1 probes. When the Y deflection coefficients are set to 5mV/div., these calibration voltages correspond to a screen amplitude of 4div.

The output sockets have an internal diameter of 4.9mm to accommodate the internationally accepted shielding tube diameter of modern Probes and F-series slimline probes. Only this type of construction ensures the extremely short ground connections which are essential for an undistorted waveform reproduction of non-sinusoidal high frequency signals.

Adjustment at 1kHz

The C-trimmer adjustment (low frequency) compensates the capacitive loading on the oscilloscope input (approx. 20pF for the HM604-3). By this adjustment, the capacitive division assumes the same ratio as the ohmic voltage divider to ensure the same division ratio for high and low frequencies, as for DC. (For 1:1 probes or switchable probes set to 1:1, this adjustment is neither required nor possible). A baseline parallel to the horizontal graticule lines is essential for accurate probe adjustments. (See also „Trace rotation TR“).

Connect the probes (Types HZ51, 52, 53, 54, or HZ36) to the CH.I input. One deflection coefficient in the **VOLTS/DIV** section of channel I must lit. If this is not the case depress the **CHI** pushbutton once and switch off channel II by depressing the **CHII** pushbutton once. Set input coupling **CH I** to DC (LED illuminates) and check that **GD** is switched off. The **CHI** deflection coefficient must be 5mV/div., and **TIME/DIV.** should be set to 0.2ms/div., and all variable controls to **CAL.** position. Plug the the probe tip into the appropriate calibrator output socket, i.e. 10:1 probes into the 0.2V socket, 100:1 probes into the 2V socket.

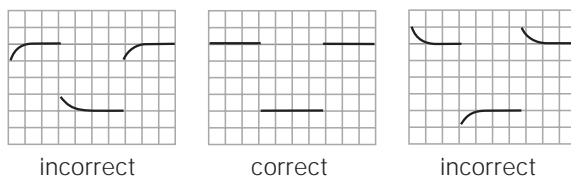

Approximately 2 complete waveform periods are displayed on the CRT screen. The compensation trimmer should be adjusted. The location of the low frequency compensation

trimmer can be found in the probe information sheet. Adjust the trimmer with the insulated screw driver provided, until the tops of the square wave signal are exactly parallel to the horizontal graticule lines (see 1kHz diagram). The signal height should then be 4div. \pm 0.16div. (= 4 % (oscilloscope 3% and probe 1%). During this adjustment, the signal edges will remain invisible.

Adjustment at 1MHz

Probes HZ51, 52 and 54 can also be HF-compensated. They incorporate resonance de-emphasizing networks (R-trimmer in conjunction with inductances and capacitors) which permit probe compensation in the range of the upper frequency limit of the vertical oscilloscope amplifier. Only this compensative adjustment ensures optimum utilisation of the full bandwidth, together with constant group delay at the high frequency end, thereby reducing characteristic transient distortion near the leading edge (e.g. overshoot, rounding, ringing, holes or bumps) to an absolute minimum.

Using the probes HZ51, 52 and 54, the full bandwidth of the HM604-3 can be utilized without risk of unwanted waveform distortion.

Prerequisite for this HF compensation is a square wave generator with fast risetime (typically 4ns), and low output impedance (approx. 50 Ω), providing 0.2V and 2V at a frequency of approx. 1MHz. The calibrator output of the HM604-3 meets these requirements when the **CAL.** pushbutton is depressed.

Connect the probe to **CH.I** input. Depress the **CAL.** pushbutton for 1MHz. Operate the oscilloscope as described under 1kHz but select for 0.2 μ s/div **TIME/DIV.** setting.

Insert the probe tip into the output socket marked 0.2V. A waveform will be displayed on the CRT screen, with leading and trailing edges clearly visible. For the HF-adjustment now to be performed, it will be necessary to observe the rising edge as well as the upper left corner of the pulse top. The location of the high frequency compensation trimmer(s) can also be found in the probe information sheet. These R-trimmer(s) have to be adjusted such that the beginning of the pulse is as straight as possible. Overshoot or excessive rounding are unacceptable. The adjustment is relatively easy if only one adjusting point is present. In case of several adjusting points the adjustment is slightly more difficult, but causes a better result. The rising edge should be as steep as possible, with a pulse top remaining as straight and horizontal as possible.

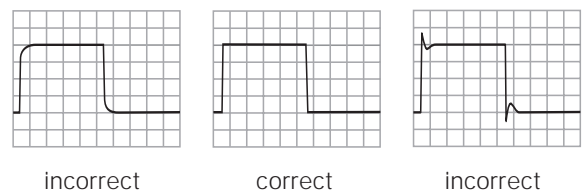

After completion of the HF-adjustment, the signal amplitude displayed on the CRT screen should have the same value as during the 1kHz adjustment.

Probes other than those mentioned above, normally have a larger tip diameter and may not fit into the calibrator outputs. Whilst it is not difficult for an experienced operator to build a suitable adapter, it should be pointed out that most of these probes have a slower risetime with the effect that the total bandwidth of scope together with probe may fall far below that of the HM604-3. Furthermore, the HF-adjustment feature is nearly always missing so that waveform distortion can not be entirely excluded.

The adjustment sequence must be followed in the order described, i.e. first at 1kHz, then at 1MHz. The calibrator frequencies should not be used for timebase calibration. The pulse duty cycle deviates from 1:1 ratio.

Prerequisites for precise and easy probe adjustments, as well as checks of deflection coefficients, are straight horizontal pulse tops, calibrated pulse amplitude, and zero-potential at the pulse base. Frequency and duty cycle are relatively unimportant. For interpretation of transient response, fast pulse risetimes and low-impedance generator outputs are of particular importance.

Providing these essential features, as well as switch-selectable output-frequencies, the calibrator of the HM604-3 can, under certain conditions, replace expensive squarewave generators when testing or compensating wideband-attenuators or -amplifiers. In such a case, the input of an appropriate circuit will be connected to one of the **CAL**-outputs via a suitable probe.

The voltage provided at a high-impedance input ($1M\Omega$ || 15-30pF) will correspond to the division ratio of the probe used (10:1 = 20mVpp, 100:1 = also 20mVpp from 2V output). Suitable probes are HZ51, 52, 53, and 54.

Operating modes of the vertical amplifiers in Yt mode.

The vertical amplifier is set to the desired operating mode by using the 2 pushbuttons **CH I** and **CH II** (for **CH I**, **CH II**, **DUAL** and **ADD** mode) in the Y field of the front panel. The different modes are indicated by LED's in the **channel I** and **channel II VOLTS/DIV** sections and the **ADD LED** in ADD mode.

If only **CH II** is active to switch to CH I mode, first press the **CH I** pushbutton to switch on channel I. Now the oscilloscope is in **DUAL** mode where LED's in both **VOLTS/DIV** sectors are lit. Then the CH II pushbutton must be depressed once to switch off channel II. It is not possible to operate the oscilloscope with both channels switched off. That is why the required channel must first be switched on and then the unwanted channel must be switched off.

To switch from CH I to CH II mode, first switch on CH II and then switch off CH I. If internal triggering is selected (EXT LED near the **TRIG. INP.** socket extinguished), the trigger source indicator LED's (**TR I** and **TR II**) will be switched over simultaneously.

DUAL mode is selected if a LED is lit in each **VOLTS/DIV** sectors. As mentioned before, one channel is always present and so the other channel must be switched on for DUAL mode operation.

In **DUAL** mode both channels are working. Two signals can be displayed together in alternate or chopped mode. The alternate mode is not suitable for displaying very slow-running processes. The display then flickers or appears to jump. Therefore the instrument automatically switches over from alternate to chopped mode if **TIME/DIV** settings from 0.5ms/div to 0.5s/div are used. If in chopped DUAL mode, both channels are switched over constantly at a high frequency within a sweep period. Low frequency signals below 1kHz, or with periods longer than 1ms are then displayed without flicker. Conversely in **DUAL** alternate mode, the displayed channel switches over from channel I to channel II and vice versa after each sweep period.

In DUAL mode the internal trigger source can be switched over from channel I to channel II and vice versa if the **TRIG.** pushbutton is depressed for a short time. Depressing the **TRIG.** pushbutton in DUAL mode for a longer time switches

over to alternate triggering and consequently both TR I and TR II LED's are lit. As alternate triggering is not possible in combination with DUAL chopped mode, the instrument automatically switches over to the alternate mode if DUAL chopped mode was active before. Alternate triggering can be switched off by depressing the **TRIG.** pushbutton for a short time. Then just one TR LED is lit.

DUAL chopped mode is also automatically switched off when TV-F (television frame triggering) is selected to avoid interference.

In combination with delay and triggered delay mode, DUAL chopped mode can also be switched to DUAL alternate mode by simultaneously depressing both pushbuttons marked with < and > arrows in the TIME/DIV sector. Any change in the delay mode time base setting reverts to the DUAL chopped mode.

ADD mode is selected by simultaneously depressing both **CH I** and **CH II** pushbuttons which causes the **ADD LED** between both pushbuttons to light.

In **ADD** mode the signals of both channels are algebraically added ($\pm I \pm II$) and displayed as one signal. Whether the resulting display shows the sum or difference is dependent on the phase relationship or the polarity of the signals and on the invert function indicated by the **INV LED's** for each channel. To quit the **ADD** mode, depress the pushbutton for the required channel or depress both CH I and CH II pushbuttons for a short time to switch back to DUAL mode. As alternate triggering is not available in ADD mode, the instrument switches over from ADD mode to alternate DUAL mode if the TRIG pushbutton is depressed for a longer time.

In **ADD** mode the following combinations are possible for

In-phase input voltages:

- Both INV (invert) function CH.I and INV (invert) function CH.II active
- released or depressed = sum.
- Only one INV (invert) function active = difference.

Antiphase input voltages:

- Both INV (invert) function active or inactive = difference.
- INV (invert) function CH.I or INV (invert) function CH.II active = sum.

In the **ADD** mode the vertical display position is dependent upon the **Y-POS.** setting of both channels. The same Y deflection coefficient is normally used for both channels with algebraic addition.

Please note that the Y-POS. settings are also added but are not affected by the INV setting.

Differential measurement techniques allow direct measurement of the voltage drop across floating components (both ends above ground). Two identical probes should be used for both vertical inputs. In order to avoid ground loops, use a separate ground connection and do not use the probe ground leads or cable shields.

X-Y Operation

For X-Y operation, the pushbutton in the X field marked XY must be depressed. Then the XY LED in the **TIME/DIV** sector is lit and the time coefficient indication is switched off. The X signal is then derived from the **INPUT CH II (X)**. The calibration of the X signal during X-Y operation is determined by the setting of the Channel II Y deflection coefficient and variable control.

This means that the sensitivity ranges and input impedances

are identical for both the X and Y axes. However, the **Y-POS.II** control is disconnected in this mode. Its function is taken over by the **X-POS.** control. It is important to note that the **X-MAG. (x10)** facility, normally used for expanding the sweep, is inoperative in the X-Y mode. It should also be noted that the bandwidth of the X amplifier is $\leq 2.5\text{MHz}$ (-3dB), and therefore an increase in phase difference between both axes is noticeable from 50kHz upwards.

The inversion of the X-input signal using the **INV CH.II** button is not possible.

Lissajous figures can be displayed in the **X-Y** mode for certain measuring tasks:

- Comparing two signals of different frequency or bringing one frequency up to the frequency of the other signal. This also applies for whole number multiples or fractions of the one signal frequency.
- Phase comparison between two signals of the same frequency.

Phase comparison with Lissajous figures

The following diagrams show two sine signals of the same frequency and amplitude with different phase angles.

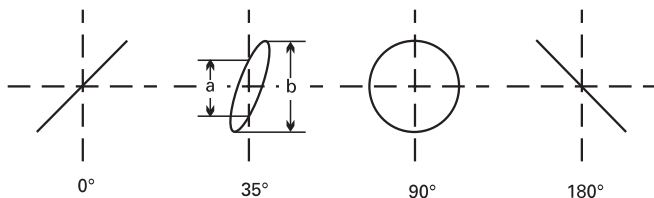

Calculation of the phase angle or the phase shift between the X and Y input voltages (after measuring the distances a and b on the screen) is quite simple with the following formula, and a pocket calculator with trigonometric functions. Apart from the reading accuracy, the signal height has no influence on the result.

$$\sin \varphi = \frac{a}{b}$$

$$\cos \varphi = \sqrt{1 - \left(\frac{a}{b}\right)^2}$$

$$\varphi = \arcsin \frac{a}{b}$$

The following must be noted here:

- Because of the periodic nature of the trigonometric functions, the calculation should be limited to angles $\leq 90^\circ$. However here is the advantage of the method.
- Do not use a too high test frequency. The phase shift of the two oscilloscope amplifiers of the HM604-3 in the X-Y mode can exceed an angle of 3° above 120kHz.
- It cannot be seen as a matter of course from the screen display if the test voltage leads or lags the reference voltage. A CR network before the test voltage input of the oscilloscope can help here. The $1\text{M}\Omega$ input resistance can equally serve as R here, so that only a suitable capacitor C needs to be connected in series. If the aperture width of the ellipse is increased (compared with C short-circuited), then the test voltage leads the reference voltage and vice versa. This applies only in the region up to 90° phase shift. Therefore C should be sufficiently large and produce only a relatively small just observable phase shift.

Should both input voltages be missing or fail in the X-Y mode, a very bright light dot is displayed on the screen. This dot can burn into the phosphor at a too high brightness setting (INTENS. knob) which causes either a lasting loss of brightness, or in the extreme case, complete destruction of the phosphor at this point.

Phase difference measurement in DUAL mode

A larger phase difference between two input signals of the same frequency and shape can be measured very simply on the screen in Dual mode. The time base should be triggered by the reference signal (phase position 0). The other signal can then have a leading or lagging phase angle.

For greatest accuracy adjust slightly over one period and approximately the same height of both signals on the screen. The variable controls for amplitude and time base and the **TRIG. LEVEL** knob can also be used for this adjustment without influence on the result. Both base lines are set onto the horizontal graticule center line with the **Y-POS.** knobs before the measurement. With sinusoidal signals, observe the zero (crossover point) transitions; the sine peaks are less accurate. If a sine signal is noticeably distorted by even harmonics, or if a **DC** voltage is present, **AC** coupling is recommended for both channels. If it is a question of pulses of the same shape, read off at steep edges. It must be noted that the phase difference cannot be determined if alternate triggering (**TR I** and **TR II** lit) is selected.

Phase difference measurement in DUAL mode

t = horizontal spacing of the zero transitions in div.
T = horizontal spacing for one period in div.

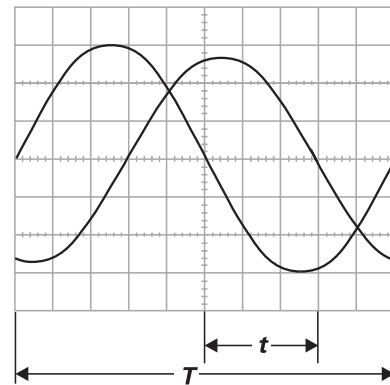

In the example illustrated, $t = 3\text{div.}$ and $T = 10\text{div.}$ The phase difference in degrees is calculated from

$$\varphi^\circ = \frac{t}{T} \cdot 360^\circ = \frac{3}{10} \cdot 360^\circ = 108^\circ$$

$$\text{arc } \varphi^\circ = \frac{t}{T} \cdot 2\pi = \frac{3}{10} \cdot 2\pi = 1,885 \text{ rad}$$

Relatively small phase angles at not too high frequencies can be measured more accurately in the X-Y mode with Lissajous figures.

Measurement of an amplitude modulation

The momentary amplitude u at time t of a HF-carrier voltage, which is amplitude modulated without distortion by a sinusoidal AF voltage, is in accordance with the equation

$u = U_T \cdot \sin \Omega t + 0,5m \cdot U_T \cdot \cos(\Omega - \omega) t - 0,5m \cdot U_T \cdot \cos(\Omega + \omega) t$
 where

- U_T = unmodulated carrier amplitude
- $\Omega = 2\pi F$ = angular carrier frequency
- $\omega = 2\pi f$ = modulation angular frequency
- m = modulation factor (i.a. ≈ 1 100%).

The lower side frequency $F-f$ and the upper side frequency $F+f$ arise because of the modulation apart from the carrier frequency F .

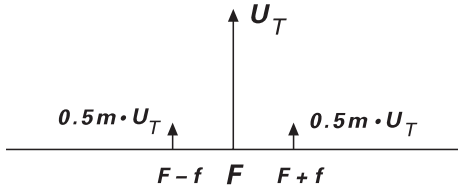

Amplitude and frequency spectrum for AM display ($m = 50\%$)

The display of the amplitude-modulated HF oscillation can be evaluated with the oscilloscope provided the frequency spectrum is inside the oscilloscope bandwidth. The time base is set so that several cycles of the modulation frequency are visible. Strictly speaking, triggering should be external with modulation frequency (from the AF generator or a demodulator). However, internal triggering is frequently possible with normal triggering (**NM LED** lit) button depressed) using a suitable **TRIG. LEVEL** setting and possibly also using the time variable adjustment.

Oscilloscope setting for a signal according to figure 2:

- Y: CH. I; 20mV/div.; AC.
- TIME/DIV.: 0.2ms/div.
- Triggering: Normal (NM LED lit); with LEVEL-setting; internal (or external) triggering.

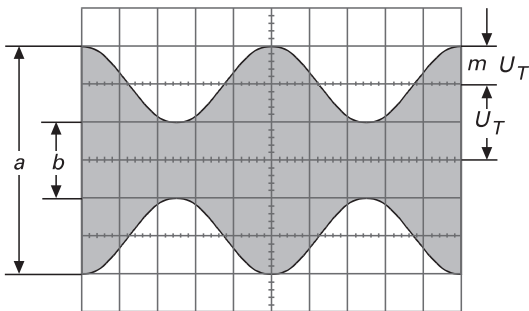

Figure 2
 Amplitude modulated oscillator: $F = 1 \text{ MHz}$; $f = 1 \text{ kHz}$;
 $m = 50\%$; $U_T = 28.3 \text{ mVrms}$.
 If the two values a and b are read from the screen, the modulation factor is calculated from

$$m = \frac{a-b}{a+b} \quad \text{bzw.} \quad m = \frac{a-b}{a+b} \cdot 100[\%]$$

where $a = U_T (1+m)$ and $b = U_T (1-m)$.

The variable controls for amplitude and time can be set arbitrarily in the modulation factor measurement. Their position does not influence the result.

Triggering and time base

Time related amplitude changes on a measuring signal (AC voltage) are displayable in Yt-mode. In this mode the signal voltage deflects the beam in vertical direction while the

timebase generator moves the beam from the left to the right of the screen (time deflection).

Normally there are periodically repeating waveforms to be displayed. Therefore the time base must repeat the time deflection periodically too. To produce a stationary display, the time base must only be triggered if the signal height and slope condition coincide with the former time base start conditions. A DC voltage signal can not be triggered as it is a constant signal with no slope.

Triggering can be performed by the measuring signal itself (internal triggering) or by an external supplied but synchronous voltage (external triggering).

The trigger voltage should have a certain minimum amplitude. This value is called the trigger threshold. It is measured with a sine signal. Except when external trigger is used the trigger threshold can be stated as vertical display height in div., through which the time base generator starts, the display is stable, and the trigger LED (located in the X field above the trigger coupling scale) lights.

The internal trigger threshold of the HM604-3 is given as $\leq 5 \text{ div}$. When the trigger voltage is externally supplied, it can be measured in Vpp at the TRIG. INP. socket. Normally, the trigger threshold may be exceeded up to a maximum factor of 20.

The HM604-3 has two trigger modes, which are characterized in the following.

Automatic Peak-Triggering

The triggering mode is indicated by the **NM LED** beside the **NORM** pushbuttons on the X field of the front panel. Automatic triggering is selected if the NM LED is unlit, otherwise simultaneously depress both NORM pushbuttons to select automatic triggering. Then the sweep generator will be running without test signal or external trigger voltage. A base line will always be displayed even with no signal. With an applied **AC** signal the peak value triggering enables the user to select the voltage point on the trigger signal, by the adjustment of the TRIG. LEVEL control. The **TRIG. LEVEL** control range depends on the peak to peak value of the signal. This trigger mode is therefore called Automatic Peak (Value)-Triggering. Operation of the scope needs only correct amplitude and timebase settings, for a constantly visible trace. Automatic mode is recommended for all uncomplicated measuring tasks. However, automatic triggering is also the appropriate operation mode for the „entry“ into difficult measuring problems, e.g. when the test signal is unknown relating to amplitude, frequency or shape. Presetting of all parameters is now possible with automatic triggering; the change to normal triggering can follow thereafter. **AUTO SET** therefore sets the instrument to automatic peak-triggering mode in combination with AC trigger coupling.

The automatic triggering works above 20Hz. The failure of automatic triggering at frequencies below 20Hz is abrupt. However, it is not signified by the trigger indicator LED (above TRIG.) this is still blinking. Break down of triggering is best recognizable at the left screen edge (the start of the trace in differing display height).

The automatic peak triggering operates over all variations or fluctuations of the test signal above **20Hz**. However, if the pulse duty factor of a square-wave signal exceeds a ratio of 100:1, switching over to normal triggering will be necessary. As the peak value detection makes no sense in combination with DC signals, it is switched off automatically in DC trigger

coupling mode. In this case the automatic is still present, but a wrong **TRIG. LEVEL** setting causes an untriggered display. Automatic triggering is practicable with internal and external trigger voltage.

In alternate triggering mode (TR I and TR II lit) the peak value detection is switched off.

Normal Triggering

With normal triggering (both **NORM** pushbuttons depressed until the **NM LED** is lit) and **TRIG. LEVEL** adjustment, the sweep can be started by AC signals within the frequency range defined by the TRIG. coupling setting. In the absence of an adequate trigger signal or when the trigger controls (particularly the TRIG. LEVEL control) are misadjusted, no trace is visible, i.e. the screen blanked completely.

When using the internal normal triggering mode, it is possible to trigger at any amplitude point of a signal edge, even with very complex signal shapes, by adjusting the TRIG. LEVEL control. Its adjusting range is directly dependent on the display height, which should be at least 0.5div. If it is smaller than 1div., the TRIG. LEVEL adjustment needs to be operated with a sensitive touch. In the external normal triggering mode, the same applies to approx. 0.3Vpp external trigger voltage amplitude.

Other measures for triggering of very complex signals are the use of the time base variable control and HOLDOFF time control, hereinafter mentioned.

Slope

The time base generator can be triggered by a rising or falling edge of the test signal. The \pm pushbutton marking selects the slope polarity. If the LED above the pushbutton is lit, the (-) falling edge is used for triggering. This is valid with automatic and normal triggering. The positive (+) slope direction (LED dark) means an edge going from a negative potential and rising to a positive potential. This has nothing to do with zero or ground potential and absolute voltage values. The positive slope may also lie in a negative part of a signal. A falling (-) edge will trigger the timebase when the minus symbol is lit.

However the trigger point may be varied within certain limits on the chosen edge using the LEVEL control. The slope direction is always related to the input signal and the non inverted display.

Trigger coupling

The coupling mode and accordingly the frequency range of the trigger signal can be changed using the upper or lower **NORM** pushbutton. The selected coupling mode is indicated on the LED scale above.

AC: Trigger range <20Hz to 100MHz.

This is the most frequently used trigger mode. The trigger threshold is increasing below 20Hz and above 100MHz.

The AUTO SET function always selects AC trigger coupling.

DC: Trigger range DC to 100MHz.

DC triggering is recommended, if the signal is to be triggered with quite slow processes or if pulse signals with constantly changing pulse duty factors have to be displayed.

With DC- or LF-trigger coupling, always work with normal triggering (NM) and TRIG.LEVEL adjustment. If

automatic (peak-value) triggering was in use, **the peak value detection is then switched off automatically.**

LF: Trigger range DC to 1.5kHz (low-pass filter).

The LF coupling is often more suited for low-frequency signals than the DC coupling, because the (white) noise in the trigger voltage is strongly suppressed. So jitter or double-triggering of complex signals is avoidable or at least reduced, in particular with very low input voltages. The trigger threshold increases above 1.5kHz.

TV-L / TV-F: The built-in active TV-Sync-Separator provides the separation of sync pulses from the video signal. Even distorted video signals are triggered and displayed in a stable manner.

Video signals are triggered in the automatic mode (NM LED dark). The internal triggering is virtually independent of the display height, but the sync pulse must exceed 0.5div. height. TV-L is for line sync pulse separation and triggering, while TV-F is for field sync pulse separation and triggering.

The slope of the leading edge of the synchronization pulse is critical for the **SLOPE** selection. If the displayed sync pulses are above the picture (field) contents (leading edge positive going), then the positive going **SLOPE (+)** must be chosen. In the case of sync pulses below the field/line, the leading edge is negative and - (minus) symbol above the \pm pushbutton must lit. Since the INV (invert) function may cause a misleading display, it must not be activated (INV LED dark).

On the 2ms/div setting and field TV triggering (TV-F) selected 1 field is visible if a 50 fields/s signal is applied. If the hold off control is in fully ccw position, it triggers without line interlacing affects caused by the consecutive field. More details in the video signal become visible if in delayed trigger mode the timebase speed is increased (see **DELAY / AFTER DELAY TRIGGERING**). The X-MAG. (x10) expansion may also be used (x10 LED lit). The influence of the integrating network which forms a trigger pulse from the vertical sync pulses may become visible under certain conditions. Due to the integrating network time constant not all vertical sync pulses starting the trace are visible.

Disconnecting the trigger circuit (e.g. by double depressing and releasing the **EXT.** button next to the **TRIG. INP.**

BNC socket in the Y field) can usually result in triggering the consecutive (odd or even) field.

On the 10 μ s/div setting and line TV triggering (**TV-L**) selected, approx. 1½ lines are visible. Those lines originate from the odd and even fields at random.

The sync-separator-circuit also operates with external triggering. It is important that the voltage range (0.3Vpp to 3Vpp) for external triggering should be noted. Again the correct slope setting is critical, because the external trigger signal may not have the same polarity or pulse edge as the test signal displayed on the CRT. This can be checked, if the external trigger voltage itself is displayed first (with internal triggering).

In most cases, the composite video signal has a high DC content. With constant video information (e.g. test pattern or color bar generator), the DC content can be suppressed easily by AC input coupling of the oscilloscope amplifier. With a changing picture content (e.g. normal program), DC input coupling is recommended, because the display varies its vertical position on screen with AC input coupling at each change of the picture content. The DC content can be compensated using the **Y-POS.** control so that the signal display lies in the graticule area. Then the composite video signal should not exceed a vertical height of 6div.

Line triggering (~)

A voltage originating from mains/line (50 to 60Hz) is used for triggering purposes if the trigger coupling (**TRIG.**) is set to ~. This trigger mode is independent of amplitude and frequency of the Y signal and is recommended for all mains/line synchronous signals. This also applies within certain limits, to whole number multiples or fractions of the line frequency. Line triggering can also be useful to display signals below the trigger threshold (less than 0.5div). It is therefore particularly suitable for measuring small ripple voltages of mains/line rectifiers or stray magnetic field in a circuit. In this trigger mode the ± (**SLOPE**) pushbutton selects the positive or negative portion of the line sinewave. The **TRIG. LEVEL** control can be used for trigger point adjustment.

Magnetic leakage (e.g. from a power transformer) can be investigated for direction and amplitude using a search or pick-up coil. The coil should be wound on a small former with a maximum of turns of a thin lacquered wire and connected to a BNC connector (for scope input) via a shielded cable. Between cable and BNC center conductor a resistor of at least 100Ω should be series-connected (RF decoupling). Often it is advisable to shield statically the surface of the coil. However, no shorted turns are permissible. Maximum, minimum, and direction to the magnetic source are detectable at the measuring point by turning and shifting the coil.

Alternate triggering

With alternate triggering (**TR I** and **TR II LED's** lit) it is possible to trigger two signals which are different in frequency (asynchronous). In this case the oscilloscope must be operated in **DUAL** alternate mode and internal triggering each input signal must be of sufficient height to enable trigger. To select for alternate triggering the **TRIG.** pushbutton must be held depressed until both **TR I** and **TR II LED's** are illuminated. To avoid trigger problems due to different DC voltage components, AC input coupling for both channels is recommended.

The internal trigger source is switched in alternate trigger mode in the same way as the channel switching system in **DUAL** alternate mode, i.e. after each time base sweep. If a timebase range (**TIME/DIV**) is chosen where the chopper generator is automatically activated, switching to alternate trigger will automatically switch off the chopper generator, and activate **DUAL** alternate mode. This measure is required as the chopper generator chops randomly without synchronization to the time base. Phase difference measurement is not possible in this trigger mode as the trigger level and slope setting are equal for both signals. Even with 180° phase difference between both signals, they appear with the same slope direction.

External triggering

When in internal trigger mode the **EXT LED** in the Y field is dark. Depressing the pushbutton below the **EXT** indicator switches the **EXT LED** on. Now the internal triggering is disconnected and the timebase can be triggered externally via the **TRIG. INP.** socket using a 0.3Vpp to 3Vpp voltage, which is in synchronism with the test signal. This trigger voltage may have a completely different form from the test signal voltage. Triggering is even possible in certain limits with whole number multiples or fractions of the test frequency, but only with synchronous signals.

The input impedance of the **TRIG. INP.** socket is approx. 100kΩ || 10pF.

The maximum input voltage of the input circuit is 100V (DC+peak AC).

It must be noted that a different phase angle between the measuring and the triggering signal may cause a display not coinciding with the slope pushbutton setting. The trigger coupling selection can also be used in external triggering mode.

Trigger indicator

An LED on condition (above the **TRIG.** symbol) indicates that the trigger signal has a sufficient amplitude and the **TRIG. LEVEL** control setting is correct. This is valid with automatic and with normal triggering. By observing the trigger LED, sensitive **TRIG. LEVEL** adjustment is possible when normal triggering is used, particularly at very low signal frequencies. The indication pulses are of only 100ms duration.

Thus for fast signals the LED appears to glow continuously, for low repetition rate signals, the LED flashes at the repetition rate or at a display of several signal periods not only at the start of the sweep at the left screen edge, but also at each signal period.

In automatic triggering mode the sweep generator starts repeatedly without test signal or external trigger voltage. If the trigger signal frequency is <20Hz the sweep generator starts without awaiting the trigger pulse. This causes an untriggered display and a flashing trigger LED.

Holdoff-time adjustment

If it is found that a trigger point cannot be found on extremely complex signals, even after careful adjustment of the **TRIG. LEVEL** control, a stable display may often be obtained using the **HOLD OFF** control (in the X-field). This facility varies the holdoff time between two sweep periods approx. up to the ratio 10:1. Pulses or other signal waveforms appearing during this off period cannot trigger the timebase.

Particularly with burst signals or aperiodic pulse trains of the same amplitude, the start of the sweep can be delayed until the optimum or required time. Another way to trigger such signals, is to operate the instrument in **DELAY** mode. The function of this control is again to delay the sweep start but the delay time is then visible on the screen as the delay position (**DEL. POS.**). See **DELAY/After DELAY** Triggering.

A very noisy signal or a signal with a higher interfering frequency is at times displayed double. It is possible that LEVEL adjustment only controls the mutual phase shift, but not the double display. The stable single display of the signal, required for evaluation, is easily obtainable by expanding the hold off time. To this end the HOLD OFF knob is slowly turned to the right, until one signal is displayed.

A double display is possible with certain pulse signals, where the pulses alternately show a small difference of the peak amplitudes. Only a very exact **TRIG. LEVEL** adjustment makes a single display possible. The use of the **HOLD OFF** knob simplifies the right adjustment.

After specific use the **HOLD OFF** control should be reset into its calibration detent (fully ccw), otherwise the brightness of the display is reduced drastically. The function is shown in the following figures.

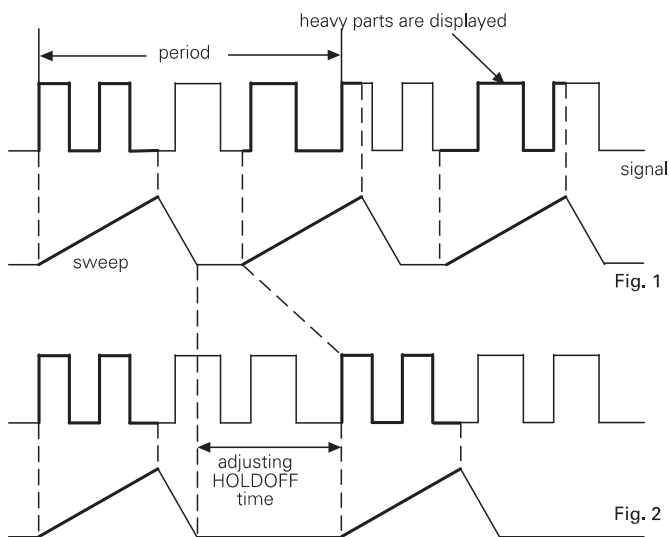

Fig. 1 shows a case where the HOLD OFF knob is in the minimum position (x1) and various different waveforms are overlapped on the screen, making the signal observation unsuccessful.

Fig. 2 shows a case where only the desired parts of the signal are stably displayed.

Delay / After Delay Triggering

As mentioned before, triggering starts the time base sweep and unblanks the beam. After the maximum X deflection to the right, the beam is blanked and flies back to the (left) start position. After the hold off period the sweep is started automatically by the automatic trigger or the next trigger signal. In normal triggering mode the automatic trigger is switched off and will only start on receipt of a trigger signal.

As the trigger point is always at the trace start position, trace expansion in X direction with the aid of the timebase is limited to the display on the left of the trace. Parts of the signal to be expanded which are displayed near the trace end (right side of the screen) are lost when the timebase speed is increased (time coefficient reduced).

The delay function delays the trace start by a variable time from the trigger point. This allows the sweep to begin on any portion of a signal. The timebase speed can then be increased to expand the display in X direction. With higher expansion rates, the intensity reduces and within certain limits this can be compensated by the **INTENS** knob setting.

If the display shows jitter, it is possible to select for (second) triggering after the elapsed delay time (DTR).

As mentioned before, it is possible to display video signals using the frame sync pulses for triggering (TV-F). After the delay time set by the operator, the next line sync pulse or the line content may be used for triggering. So data lines and test lines can be displayed separately.

Operation of the delay function is relatively simple. Without delay function (no LED on the DELAY scale in the X field lit) set the time coefficient setting (**TIME/DIV**) until 1 to 3 signal periods are displayed. Display of less than one period should be avoided as it limits the selection of the signal section to be expanded, and may cause trigger problems.

The X MAG (x10) function should be switched off and the time variable control should be in CAL position. The signal must be triggered and stable. The following explanation assumes that the trace starts on the left vertical graticule line.

Photo 1 (composite video signal)

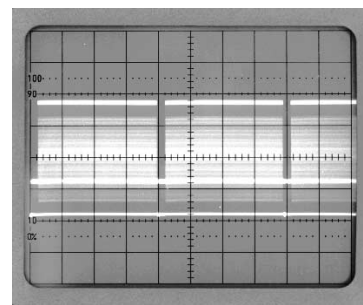

MODE: undelayed
TIME/DIV: 5ms/div
Trigger coupling: TV-F
Trigger slope: falling (-)

Depressing the DELAY pushbutton once for a short time, lights the **SEA (SEARCH)** LED on the DELAY scale. In all delay modes, the **DEL. POS.** knob assumes the function of **DEL. POS.** (delay position), and the hold off time defaults to x1. Now the function of this knob (**DEL. POS.**) is to adjust the delay time, indicated as a blanked part of the screen. The length of the blanked sector depends on the **DEL. POS.** setting and can be set between approx. one and six division after the normal trace start position. As the trace right end is not effected, the visible trace length is reduced. In delay (DEL) mode, the trace will start from the normal left end where the blanking starts. If the maximum delay is not sufficient, the time coefficient must be increased (TIME/DIV left arrow pushbutton) and the **DEL. POS.** knob set to the later starting point. To return to normal (undelayed operation), depress the **DELAY** pushbutton for a longer time or step through the different **DELAY** functions until no LED on the **DELAY** scale is lit.

Photo 2

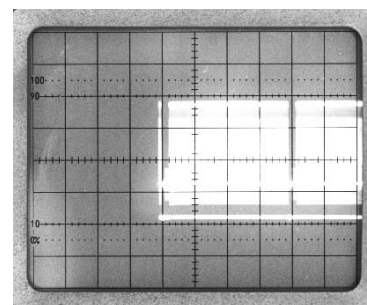

MODE: SEA (SEARCH)
TIME/DIV: 5ms/div
Trigger coupling: TV-F
Delay time:
4div x 5ms = 20ms

Photo 2 shows that the delay time can be measured. It is identical with the delayed position of the trace start and can be calculated by multiplying the delay length measured in div. and the actual calibrated time coefficient.

If in search (**SEA**) mode the next short depression of the DELAY pushbutton switches over to DEL (**LED lit**).

The blanked period indicating the delay time is switched off and the trace has its normal - unreduced-, length.

The trace starts on its previous X position (without **DELAY** mode), beginning with the signal part first visible in search (**SEA**) mode after the delay time. When the delay (**DEL**) mode is in operation, it might even maximum intensity may not be sufficient. In this case the timebase speed should be reduced by increasing the time coefficient (**TIME/DIV**), to a slower speed.

As mentioned before, the main purpose of the delay mode is to make signal magnification in X direction possible.

This is the reason why the time coefficient in DEL mode cannot be set to higher values than used during **SEA** (search) operation. **DEL** mode speeds must always be faster.

Please note that the previous time coefficient chosen in DEL and DTR mode is stored and automatically set after activating one of those modes. If the stored time coefficient in **DEL** or

DTR mode was higher than the actual value in SEA (search) mode, the time coefficient in DEL or DTR mode is automatically set to the value used during SEA (search) operation.

Photo 3

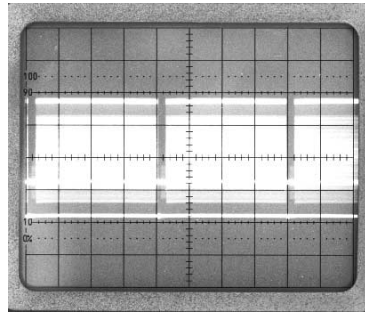

MODE: DEL (DELAY)
 TIME/DIV: 5ms/div
 Trigger coupling: TV-F
 Trigger slope: falling (-)
 Delay time: 20ms

Reducing the time coefficient (increasing the time base speed) now expands the signal. If the signal start position is not set to the optimum, it can still be shifted in the X direction by turning the DEL. POS. knob. Photo 4 shows a 50 fold X magnification caused by setting the time coefficient to 0.1 ms/div (5ms/div : 0.1ms/div = 50). The reading accuracy also increases with higher X magnification. As already mentioned, the time variable control must be in CAL position when measurements are taken.

Photo 4

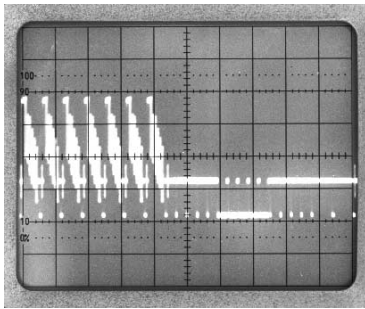

MODE: DEL (DELAY)
 TIME/DIV: 0.1ms/div
 Trigger coupling: TV-F
 Trigger slope: falling (-)
 Delay time: 20ms

It is possible to trigger after the delay time on the next suitable slope. This avoids jitter which may occur when high X magnification rates are used. Depressing the DELAY pushbutton for a short time switches over from delay (DEL) mode to triggered delay mode and the DTR LED lights. The trigger settings (automatic peak / normal triggering, trigger coupling, TRIG. LEVEL and slope) already selected do not change. In after delay triggering mode (DTR) the instrument is automatically set to normal triggering (NM) and DC trigger coupling (DC). Neither setting can be changed (NM, DC) and the indicator LED's remain lit. Only the trigger level (TRIG. LEVEL) and the trigger slope direction (\pm) can be used, for selecting the signal part which should be used for triggering. If the signal height is too small or the TRIG. LEVEL setting is unsuitable, no trace appears, and the screen is dark. Under these DELAY conditions a X position shift is possible by varying the delay time (DEL. POS.) if the settings are suitable. Unlike the untriggered delay mode (DEL) where a continuous shift is the result, in trigger after delay mode (DTR) the signal jumps from one signal slope to the next with a simple, repetitive signal, this may not be apparent in DTR mode. In the case of TV trigger mode, triggering is possible on line pulses and on continuously repeating slopes in the picture content.

The X magnification is limited by the decreasing trace intensity. The 50 fold X magnification which was used for the screen photos is just an example.

Depressing the delay pushbutton in DTR mode once again switches back to the normal operating conditions where

no LED on the DELAY scale is lit. The instrument then is set automatically to the operating conditions used before switching over to DEL.

Please note: If the instrument is operated in Dual mode under conditions where DUAL chopped mode is active, this display mode is not switched off when time coefficients are being reduced (0.2ms/div to 0.05 μ s/div) for signal expansion in DEL and DTR mode. Under certain conditions depending on the signal frequency and the expansion rate, the unblanking during the channel switching may become visible. The chopper generator can be switched off under these conditions by simultaneously depressing both arrow pushbuttons in the TIME/DIV. sector. Any timebase change after this procedure will switch the chopper generator on again. The chopper generator then can be deactivated in the same way.

AUTO SET

As mentioned most of the controls and their settings are electronically selected. The exceptions are the **POWER** and the calibrator frequency pushbuttons, as well as the **DEL. POS./HOLD OFF, INTENS, FOCUS** and **TR** (trace rotation) controls. Thus automatic signal related instrument set up in Yt (timebase) mode is possible. In most cases no additional manual instrument setting is required.

Brief depressing of the **AUTO SET** pushbutton causes the instrument to switch over to the last Yt mode settings regarding **CH I, CH II** and **DUAL**. If the instrument was operated in Yt mode, the actual setting will not be affected with the exception of ADD mode which will be switched off. At the same time the attenuator(s) (**VOLTS/DIV**) are automatically set for a signal display height of approx. 6 div. in mono channel mode or if in **DUAL** mode for approx. 4 div height for each channel. This and the following explanation regarding the automatic time coefficient setting assumes that the pulse duty factor is approx. 1:1.

The time deflection coefficient is also set automatically for a display of approx. 2 signal periods. The time base setting occurs randomly if complex signals consisting several frequencies e.g. video signals are present.

AUTO SET sets the instrument automatically to the following operating conditions:

- **AC** input coupling
- Internal triggering
- Automatic peak (value) triggering
- Trigger level (**TRIG. LEVEL**) electrical midrange position (the mechanical position may deviate)
- Y deflection coefficient(s) calibrated (the fine control knob may not be in CAL position)
- Time deflection coefficient calibrated (the fine control knob may not be in CAL position)
- **AC** trigger coupling
- **DELAY** mode **switched off**
- **X x10** magnifier **switched off**
- Automatic X and Y position settings (the mechanical knob position may deviate)

The automatically set operating conditions in **AUTO SET** mode are taken over by the instrument regardless whether the mechanical knob settings coincide or not. If a knob is not in its calibrated detent (**CAL**), the LED stops blinking. Turning the knob reverts to the actual mechanical setting.

The 1mV/div. and 2mV/div. deflection coefficient will not be set by **AUTO SET** as the bandwidth is reduced in these settings. This is indicated by red LED's on the scale.

SAVE/RECALL

The instrument contains a non volatile memory in which the actual instruments settings are stored when the instrument is switched off. After switching on the oscilloscope and a short internal check routine the last settings become active again.

The memory mentioned before can also be used by the operator to save 6 different instrument settings and to recall them. This relates to all settings with the exception off **INTENS, FOCUS, TR** (trace rotation), **DEL. POS./HOLD OFF** and the calibrator frequency pushbutton.

To **SAVE** a particular front panel set up:

Press **SAVE/RECALL** pushbutton briefly. Now the trigger coupling scale has the function of a memory location indicator. The memory location number is indicated on the left side of the scale below the S/R marking. After the **SAVE/RECALL** pushbutton was briefly depressed for the first time the S/R 1 (DC) LED will blink. The memory location can now be chosen, selecting it by depressing one of the NORM (up / down) pushbuttons; this causes no change in the trigger coupling setting. **SAVE** the front panel setting by depressing the **SAVE/RECALL** pushbutton until LED stops blinking. The trigger coupling active before starting the **SAVE/RECALL** procedure (and was saved) then becomes active again.

To **RECALL** a front panel set up:

Press **SAVE/RECALL** pushbutton briefly. Now the trigger coupling scale has the function of a memory location indicator. The memory location number is indicated on the left side of the scale below the S/R marking. After the **SAVE/RECALL** pushbutton was briefly depressed for the first time the S/R 1 (DC) LED will blink. The memory location can now be chosen, selecting it by depressing one of the **NORM** (up / down) pushbuttons; this causes no change in the trigger coupling setting. **RECALL** the front panel setting by depressing the **SAVE/RECALL** pushbutton briefly. The LED will stop blinking and the selected set up is enabled. The LED display will now show the recalled trigger coupling mode.

The recalled operating conditions are taken over by the instrument regardless of whether the mechanical knob settings coincide or not. If a knob is not in its calibrated detent (CAL), the LED stops blinking. Turning the knob then reverts to the actual mechanical setting.

To interrupt a **SAVE** or **RECALL** procedure:

If the **SAVE/RECALL** pushbutton was depressed inadvertently, the procedure can be interrupted by depressing any electronic selection pushbutton with the exception of the **SAVE/RECALL** and **NORM** pushbuttons.

Component Tester

The HM604-3 has a built-in electronic Component Tester (COMP. TESTER), which is used for instant display of a test pattern to indicate whether or not components are faulty. The **COMP. TESTER** can be used for quick checks of semiconductors (e.g. diodes and transistors), resistors, capacitors, and inductors. Certain tests can also be made to integrated circuits. All these components can be tested in and out of circuit.

The test principle is fascinatingly simple. A built-in generator delivers a sine voltage, which is applied across the component under test and a built-in fixed resistor. The sine voltage across the test object is used for the horizontal deflection, and the voltage drop across the resistor (i.e. current through test object) is used for vertical deflection of the oscilloscope. The test pattern shows a current-voltage characteristic of the test object.

Since this circuit operates with a frequency of 50Hz ($\pm 10\%$) and a voltage of approx. 7V max. (open circuit), the indicating range of the component tester is limited. The impedance of the component under test is limited to a range from 20Ω to $4.7k\Omega$. Below and above these values, the test pattern shows only short-circuit or open-circuit. For the interpretation of the displayed test pattern, these limits should always be borne in mind. However, most electronic components can normally be tested without any restriction.

Using the Component Tester

The instrument can be switched to component tester mode by depressing **COMP. TESTER** pushbutton once. This is completely independent from Yt or XY mode. In component tester mode, only the X MAG. x10 LED may be lit if it was previously enabled. Then the X trace length is expanded 10 fold. All other LED's are unlit.

The following description concerns the operation without X MAG. x10, with a horizontal trace length of approx. 8 div. when the component tester input's are not connected. The COMP. TESTER mode can be exited by depressing the COMP. TESTER pushbutton again, setting the instrument back to the previous mode and settings. The COMP. TESTER mode can be saved and recalled as mentioned under SAVE/RECALL.

In component tester mode, the vertical preamplifier and the timebase generator inoperative. A shortened horizontal trace will be observed. It is not necessary to disconnect scope input cables unless in-circuit measurements are to be carried out. In the COMP. TESTER mode, the only controls which can be operated are INTENS., FOCUS, X-POS. and X MAG. x10. All other controls except the X MAG. x10 have no influence on the test operation.

For the component connection, two simple test leads with 4mm \varnothing banana plugs, and with test prod, alligator clip or sprung hook, are required. The test leads are connected to the insulated socket and the adjacent ground socket beneath the screen. The component can be connected to the test leads either way round.

Test Procedure

Caution! Do not test any component in live circuitry - remove all grounds, power and signals connected to the component under test. Set up Component Tester as stated above. Connect test leads across component to be tested. Observe oscilloscope display.

Only discharged capacitors should be tested!

Test Pattern Displays

In the following typical test patterns show various components under test.

- Open circuit is indicated by a straight horizontal line.
- Short circuit is shown by a straight vertical line.

Testing Resistors

If the test object has a linear ohmic resistance, both deflecting voltages are in the same phase. The test pattern expected from a resistor is therefore a sloping straight line. The angle of slope is determined by the resistance of the resistor under test. With high values of resistance, the slope will tend towards the horizontal axis, and with low values, the slope will move towards the vertical axis.

Values of resistance from 20Ω to $4.7k\Omega$ can be approximately evaluated. The determination of actual values will come with experience, or by direct comparison with a component of a known value.

Testing Capacitors and Inductors

Capacitors and inductors cause a phase difference between current and voltage, and therefore between the X and Y deflection, giving an ellipse-shaped display. The position and opening width of the ellipse will vary according to the impedance value (at 50Hz) of the component under test.

- A horizontal ellipse indicates a high impedance or a relatively small capacitance or a relatively high inductance.
- A vertical ellipse indicates a small impedance or a relatively large capacitance or a relatively small inductance.
- A sloping ellipse means that the component has a considerable ohmic resistance in addition to its reactance.

The values of capacitance of normal or electrolytic capacitors from $0.1\mu F$ to $1000\mu F$ can be displayed and approximate values obtained. More precise measurement can be obtained in a smaller range by comparing the capacitor under test with a capacitor of known value. Inductive components (coils, transformers) can also be tested. The determination of the value of inductance needs some experience, because inductors have usually a higher ohmic series resistance. However, the impedance value (at 50Hz) of an inductor in the range from 20Ω to $4.7k\Omega$ can easily be obtained or compared.

Testing Semiconductors

Most semiconductor devices, such as diodes, Z-diodes, transistors, FETs can be tested. The test pattern displays vary according to the component type as shown in the figures below.

The main characteristic displayed during semiconductor testing is the voltage dependent knee caused by the junction changing from the conducting state to the non conducting state. It should be noted that both the forward and the reverse characteristic are displayed simultaneously. This is a two-terminal test, therefore testing of transistor amplification is not possible, but testing of a single junction is easily and quickly possible. Since the test voltage applied is only very low, all sections of most semiconductors can be tested without damage. However, checking the breakdown or reverse voltage of high voltage semiconductors is not possible. More important is testing components for open or short-circuit, which from experience is most frequently needed.

Testing Diodes

Diodes normally show at least their knee in the forward characteristic. This is not valid for some high voltage diode types, because they contain a series connection of several diodes. Possibly only a small portion of the knee is visible. Z-diodes always show their forward knee and, up to approx.

7V, their Z-breakdown, forms a second knee in the opposite direction. A Z-breakdown voltage of more than 6.8V can not be displayed.

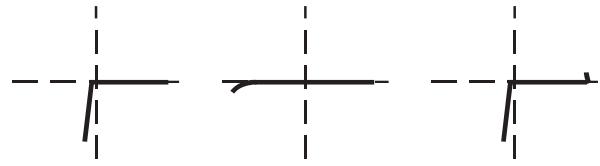

Type:	Normal Diode	High Voltage Diode	Z-Diode 6.8V
Terminals:	Cathode-Anode	Cathode-Anode	Cathode-Anode
Connections:	(CT-GD)	(CT-GD)	(CT-GD)

The polarity of an unknown diode can be identified by comparison with a known diode.

Testing Transistors

Three different tests can be made to transistors: base-emitter, base-collector and emitter-collector. The resulting test patterns are shown below.

The basic equivalent circuit of a transistor is a Z-diode between base and emitter and a normal diode with reverse polarity between base and collector in series connection. There are three different test patterns:

N-P-N Transistor

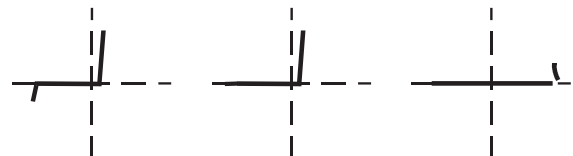

Terminals:	b-e	b-c	e-c
Connections:	(CT-GD)	(CT-GD)	(CT-GD)

P-N-P Transistor



Terminals:	b-e	b-c	e-c
Connections:	(CT-GD)	(CT-GD)	(CT-GD)

For a transistor the figures b-e and b-c are important. The figure e-c can vary; but a vertical line only shows short circuit condition. These transistor test patterns are valid in most cases, but there are exceptions to the rule (e.g. Darlington, FETs). With the **COMP. TESTER**, the distinction between a P-N-P to an N-P-N transistor is discernible. In case of doubt, comparison with a known type is helpful. It should be noted that the same socket connection (**COMP. TESTER** or ground) for the same terminal is then absolutely necessary. A connection inversion effects a rotation of the test pattern by 180 degrees round about the center point of the scope graticule.

In-Circuit Tests

Caution! During in-circuit tests make sure the circuit is dead. No power from mains/line or battery and no signal inputs are permitted. Remove all ground connections including Safety Earth (pull out power plug from outlet). Remove all measuring cables including probes between oscilloscope and circuit under test. Otherwise both COMP. TESTER leads are not isolated against the circuit under test.

In-circuit tests are possible in many cases. However, they are not well defined. This is caused by a shunt connection of real or complex impedances - especially if they are of relatively low impedance at 50Hz - to the component under test, often results differ greatly when compared with single components. In case of doubt, one component terminal may be unsoldered. This terminal should then be connected to the insulated COMP. TESTER socket avoiding hum distortion of the test pattern.

Another way is a test pattern comparison to an identical circuit which is known to be operational (likewise without power and any external connections). Using the test prods, identical test points in each circuit can be checked, and a defect can be determined quickly and easily. Possibly the device itself under test contains a reference circuit (e.g. a second stereo channel, push-pull amplifier, symmetrical bridge circuit), which is not defective. The test patterns show some typical displays for in-circuit tests.

Test patterns

Single Components



Short circuit



Resistor 510Ω



Main transformer prim.

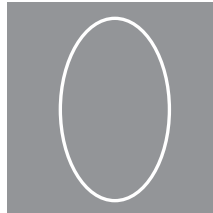

capacitor 33μF

Single Transistors

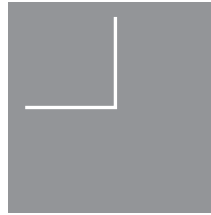

Junction B-C



Junction B-E



Junction E-C



FET

Single Diodes



Z-Diode below 7V



Z-Diode beyond 7V



Silicon diode



Germanium diode

In-circuit Semiconductors



Diode paralleled by 680Ω



2 Diodes antiparallel



Silicon diode



Germanium diode



Diode in series with 51Ω

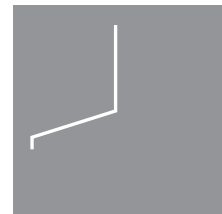

B-E parallel by 680Ω



Rectifier



Thyristor, G + A together



B-E with 1μF+680Ω



Si.-Diode with 10mF

Test Instructions

General

These Test Instructions are intended as an aid for checking the most important characteristics of the HM604-3 at regular intervals without the need for expensive test equipment. Resulting corrections and readjustments inside the instrument, indicated by the following tests, are described in the Service Instructions or on the Adjusting Plan. They should only be undertaken by qualified personnel.

As with the First Time Operation instructions, care should be taken that all knobs with arrows are set to their calibrated positions. Depress AUTO SET for default settings. It is recommended to switch on the instrument for about 20 minutes prior to the commencement of any check.

Cathode-Ray Tube: Brightness and Focus, Linearity, Raster Distortions

Normally, the CRT of the HM604-3 has very good brightness. Any reduction of this brightness can only be judged visually. However, decreased brightness may be the result of wrong settings or reduced high voltage. The latter is easily recognized by the greatly increased sensitivity of the vertical amplifier. Correct setting means, that the HOLD OFF control should be turned to the left stop; the X-MAG. x10 function should be switched off; a medium time coefficient should be selected; line triggering (~ indicated) should be used only with a suitable TIME/DIV. setting (e.g. 2ms/div.). The control range for maximum and minimum brightness (intensity) must be such that the beam just disappears before reaching the left hand stop of the INTENS. control (particularly when in XY mode), while with the control at the right hand stop the focus and the line width are just acceptable.

With maximum intensity the timebase fly-back must on no account be visible. Visible trace fault without input signal: bright dot on the left side or decreasing brightness from left to right or shortening of the baseline. (Cause: Incorrect Unblanking Pulse.)

It should be noted that with wide variations in brightness, refocusing is always necessary. Moreover, with maximum brightness, no „pumping“ of the display must occur. If pumping does occur, it is normally due to a fault in the regulation circuitry for the high voltage supply. The presetting pots for the high voltage circuit, minimum and maximum intensity, are only accessible inside the instrument.

A certain out-of-focus condition in the edge zone of the screen must be accepted. It is limited by standards of the CRT manufacturer. The same is valid for tolerances of the orthogonality, the undeflected spot position, the non-linearity and the raster distortion in the marginal zone of the screen in accordance with international standards (see CRT data book). These limit values are strictly supervised by HAMEG. The selection of a cathode-ray tube without any tolerances is practically impossible.

Astigmatism Check

Check whether the horizontal and vertical sharpness of the display are equal. This is best seen by displaying a square-wave signal with the repetition rate of approximately 1MHz. Focus the horizontal tops of the square-wave signal at normal intensity, then check the sharpness of the vertical edges. If it is possible to improve this vertical sharpness by turning the FOCUS control, then an adjustment of the astigmatism control is necessary. A potentiometer of 47k Ω is provided inside the instrument for the correction of astigmatism. A certain loss of marginal sharpness of the CRT is unavoidable; this is due to the manufacturing process of the CRT.

Symmetry and Drift of the Vertical Amplifier

Both of these characteristics are substantially determined by the input stages of the amplifiers.

The symmetry of both channels and the vertical final amplifier can be checked by inverting Channel I and II (depress the corresponding INV pushbutton). The vertical position of the trace should not change by more than 0.5div. However, a change of 1div. is just permissible. Larger deviations indicate that changes have occurred in the amplifier.

A further check of the vertical amplifier symmetry is possible by checking the control range of the Y-POS. controls. A sine-wave signal of 10-100kHz is applied to the amplifier input. When the Y-POS. control is then turned fully in both directions from stop to stop with a display height of approximately 8div., the upper and lower positions of the trace that are visible should be approximately of the same height. Differences of up to 1div. are permissible (input coupling should be set to AC).

Checking the drift is relatively simple. 20minutes after switching on the instrument, set the baseline exactly on the horizontal center line of the graticule. The beam position must not change by more than 0.5div. during the following hour.

Calibration of the Vertical Amplifier

Two square-wave voltages of 0.2Vpp \pm 1% and 2Vpp are present at the output sockets of the calibrator (CAL.) If a direct connection is made between the 0.2V output and the input of the vertical amplifier (e.g. using a x1 probe), the displayed signal in the 50mV/div. position (variable control to CAL.) should be 4div. high (DC input coupling). Maximum deviations of 0.12div. (3%) are permissible. If a x10 probe is connected between the 2V output and Y input, the same display height should result.

With higher tolerances it should first be investigated whether the cause lies, within the amplifier or in the amplitude of the square-wave signal. On occasions it is possible that the probe is faulty or incorrectly compensated. If necessary the measuring amplifier can be calibrated with an accurately known DC voltage (DC input coupling). The trace position should then vary in accordance with the deflection coefficient set.

With variable control in the attenuator sector fully counter-clockwise, the input sensitivity is decreased at least by the factor 2.5 in each position. In the 50mV/div. position, the displayed calibrator signal height should vary from 4div. to at least 1.6div.

Transmission Performance of the Vertical Amplifier

The transient response and the delay distortion correction can only be checked with the aid of a square-wave generator with a fast risetime (max. 5ns). The signal coaxial cable (e.g. HZ34) must be terminated at the vertical input of the oscilloscope with a resistor equal to the characteristic impedance of the cable (e.g. with HZ22). Checks should be made at 100Hz, 1kHz, 10kHz, 100kHz and 1MHz, the deflection coefficient should be set at 5mV/div. with DC input coupling (Y variable control in CAL. position). In so doing, the square pulses must have a flat top without ramp-off, spikes and glitches; no overshoot is permitted, especially at 1MHz and a display height of 4-5div.. At the same time, the leading top corner of the pulse must not be rounded. In general, no great changes occur after the instrument has left the factory, and it is left to the operators discretion whether this test is undertaken or not. A suited generator for this test is HZ60 from HAMEG.

Of course, the quality of the transmission performance is not only dependent on the vertical amplifier. The input attenuators, located in the front of the amplifier, are frequency-compensated in each position. Even small capacitive changes can reduce the transmission performance. Faults of this kind are as a rule most easily detected with a square-wave signal with a low repetition rate (e.g. 1kHz). If a suitable generator with max. output of 40Vpp is available, it is advisable to check at regular intervals the deflection coefficients on all positions of the input attenuators and readjust them as necessary. A compensated 2:1 series attenuator is also necessary, and this must be matched to the input impedance of the oscilloscope. This attenuator can be made up locally. It is important that this attenuator is shielded. For local manufacture, the electrical components required are a $1M\Omega \pm 1\%$ resistor and, in parallel with it, a trimmer 3-15pF in parallel with approx. 12pF. One side of this parallel circuit is connected directly to the input connector of CH.I or CH.II and the other side is connected to the generator, if possible via a low-capacitance coaxial cable. The series attenuator must be matched to the input impedance of the oscilloscope in the 5mV/div. position (variable control to CAL., DC input coupling; square tops exactly horizontal; no ramp-off is permitted). This is achieved by adjusting the trimmer located in the 2:1 attenuator. The shape of the square-wave should then be the same in each input attenuator position.

Operating Modes: CH.I/II, DUAL, ADD, CHOP, INVERT and X-Y Operation

In DUAL mode two traces must appear immediately. On actuation of the Y-POS. controls, the trace positions should have minimal effect on each other. Nevertheless, this cannot be entirely avoided, even in fully serviceable instruments. When one trace is shifted vertically across the entire screen, the position of the other trace must not vary by more than 0.5mm.

A criterion in chopped operation is trace widening and shadowing around and within the two traces in the upper or lower region of the screen. Set TIME/DIV. switch to 0.5ms/div., set input coupling of both channels to GD and advance the INTENS. control fully clockwise. Adjust FOCUS for a sharp display. With the Y-POS. controls shift one of the traces to a +2div., the other to a -2div. vertical position from the horizontal center line of the graticule.

Do not try to synchronize (with the time variable control) the chop frequency (0.5MHz)! Check for negligible trace widening and periodic shadowing when switching between 0.5ms/div and 0.2ms/div.

It is important to note that in the I+II add mode (ADD LED lights) or the I-II difference mode (one INV LED lights) the vertical position of the trace can be adjusted by using both the Channel I and Channel II Y-POS. controls.

In X-Y Operation (XY LED in TIME/DIV sector lights), the sensitivity in both deflection directions will be the same. When the signal from the built-in square-wave generator is applied to the input of Channel II, then, as with Channel I in the vertical direction, there must be a horizontal deflection of 4div. when the deflection coefficient is set to 50mV/div. position (variable control set to its CAL. position). The check of the mono channel display is unnecessary; it is contained indirectly in the tests above stated.

Triggering Checks

The internal trigger threshold is important as it determines the display height from which a signal will be stably displayed.

It should be approx. 0.3-0.5div. for the HM604-3. An increased trigger sensitivity creates the risk of response to the noise level in the trigger circuit. This can produce double-triggering with two out-of-phase traces.

Alteration of the trigger threshold is only possible internally. Checks can be made with any sine-wave voltage between 50Hz and 1MHz. The instrument should be in automatic peak (value) triggering (NM LED dark) and the TRIG. LEVEL knob in midrange position. It should be ascertained whether the same trigger sensitivity is also present with Normal Triggering (NM LED lights). In this trigger mode, TRIG. LEVEL adjustment is absolutely necessary.

The checks should show the same trigger threshold with the same frequency. On depressing the \pm (SLOPE) button, the start of the sweep changes from the positive-going to the negative-going edge of the trigger signal.

As described in the Operating Instructions, the trigger frequency range is dependent on the trigger coupling selected. For lower frequencies the LF coupling mode can be selected. In this mode, triggering up to at least 1.5kHz (sine-wave) is possible. Internally the HM604-3 should trigger perfectly at a display height of approx. 0.5div., when the appropriate trigger coupling mode is set.

For external triggering (EXT LED lights), the TRIG. INP. connector requires a signal voltage of at least 0.3Vpp, which is in synchronism with the Y input signal. The voltage value is dependent on the frequency and the trigger coupling mode (AC-DC-HF-LF).

Checking of the TV triggering is possible with a video signal of any given polarity.

Use the TV-L or TV-F setting for video sync pulse separation. With the \pm (SLOPE) button the correct slope of the sync pulse (front edge) must be selected and a suited TIME/DIV setting must be chosen. The slope is then valid for both sync frequencies.

Perfect TV triggering is achieved, when in both display modes the amplitude of the complete TV signal (from white level to the top of the line sync pulse) is limited between 0.8 and 6div and sync pulses of more than 0.5 div. height. The display should not shift horizontally during a change of the trigger coupling from AC to DC when displaying a sine-wave signal without DC offset.

If both vertical inputs are AC coupled to the same signal and both traces are brought to coincide exactly on the screen, when working in the alternate dual channel mode, then no change in display should be noticeable, when switching from TRIG I to TRIG II or when the trigger coupling is changed from AC to DC.

Checking of the line/mains frequency triggering (50-60Hz) is possible, when the input signal is time-related (multiple or submultiple) to the power line frequency (\sim LED lights). There is no trigger threshold visible in this trigger mode. Even very small input signals are triggered stably (e.g. ripple voltage). For this check, use an input of approx. 1V. The displayed signal height can then be varied by turning the respective input attenuator switch and its variable control.

Timebase

Before checking the timebase it should be ascertained that the trace length is approx. 10div. in all time ranges. If not, it can be corrected with the potentiometer X x1. This adjustment should be made with the TIME/DIV. switch in a

mid position (i.e. 20 μ s/div.). Prior to the commencement of any check set the time variable control to CAL. The X-MAG. x10 LED should not light. This condition should be maintained until the variation ranges of these controls are checked.

Check that the sweep runs from the left to the right side of the screen (TIME/DIV. setting to 0.1s/div.; X-POS. control in mid-range). This check is only necessary after changing the cathode-ray tube.

If a precise marker signal is not available for checking the Timebase time coefficients, then an accurate sine-wave generator may be used. Its frequency tolerance should not be greater than $\pm 1\%$. The timebase accuracy of the HM604-3 is given as $\pm 3\%$, but it is considerably better than this. For the simultaneous checking of timebase linearity and accuracy at least 10 oscillations, i.e. 1 cycle every div., should always be displayed. For precise determination, set the peak of the first marker or cycle peak exactly behind the first vertical graticule line using the X-POS. control. Deviation tendencies can be noted after some of the marker or cycle peaks.

If a precise Time Mark Generator is used for checking, Normal Triggering (NM LED lights) and TRIG. LEVEL control adjustment is recommended.

The following table shows which frequencies are required for the particular ranges.

0.5s/div. - 2Hz	0.1ms/div. - 10kHz
0.2s/div. - 5Hz	50 μ s/div. - 20kHz
0.1s/div. - 10Hz	20 μ s/div. - 50kHz
50ms/div. - 20Hz	10 μ s/div. - 100kHz
20ms/div. - 50Hz	5 μ s/div. - 200kHz
10ms/div. - 100Hz	2 μ s/div. - 500kHz
5ms/div. - 200Hz	1 μ s/div. - 1MHz
2ms/div. - 500Hz	0.5 μ s/div. - 2MHz
1ms/div. - 1kHz	0.2 μ s/div. - 5MHz
0.5ms/div. - 2kHz	0.1 μ s/div. - 10MHz
0.2ms/div. - 5kHz	0.05 μ s/div. - 20MHz

When the X-MAG. x10 function is active, a marker or cycle peak will be displayed every 10div. $\pm 5\%$ (with variable control in CAL. position; measurement in the 5 μ s/div. range). The tolerance is better measurable in the 50 μ s/div. range (one cycle every 1div.).

Holdoff time

The variation of the holdoff time while turning the HOLD OFF knob can not be tested without opening the instrument. However, a visual check can be made if the instrument is not operated in DELAY mode.

Without an input signal, set TIME/DIV. to 0.05 μ s/div and time variable control cw, use automatic peak (value) triggering. At the left hand stop of the HOLDOFF knob, the trace should be bright. It should noticeably darken at the right hand stop of the HOLDOFF knob.

Component Tester

After selecting component tester mode by pressing the COMP. TESTER button, a horizontal straight line should appear immediately, when the COMP. TESTER socket is open. The length of this trace should be approx. 8div if the X MAG. x10 LED is dark. With connection of the COMP. TESTER socket to the ground jack in the Y-Section, a vertical straight line with approx. 6div. height should be displayed. The above stated measurements have some tolerances.

Trace Alignment

The CRT has an admissible angular deviation $\pm 5^\circ$ between the X deflection plane D1-D2 and the horizontal center line of

the internal graticule. This deviation, due to tube production tolerances (and only important after changing the CRT), and also the influence of the earths magnetic field, which is dependent on the instruments North orientation, are corrected by means of the TR potentiometer. In general, the trace rotation range is asymmetric. It should be checked, whether the baseline can be adjusted somewhat sloping to both sides round about the horizontal center line of the graticule. With the HM604-3 in its closed case, an angle of rotation $\pm 0.57^\circ$ (0.1div. difference in elevation per 10div. graticule length) is sufficient for the compensation of the earths magnetic field.

Service Instructions

General

The following instructions are intended as an aid for the electronic technician, who is carrying out readjustments on the HM604-3, if the nominal values do not meet the specifications. These instructions primarily refer to those faults, which were found after using the Test Instructions. However, this work should only be carried out by properly qualified personnel. For any further technical information call or write to HAMEG. Addresses are provided at the back of the manual. It is recommended to use only the original packing material, should the instrument be shipped to for service or repair (see also Warranty).

Instrument Case Removal

The rear cover can be taken off after unplugging the power cords triple-contact connector and after two nuts the washers have been removed. If a cross recessed pan head screw is present on the bottom of the instrument, it must be removed too. While the instrument case is firmly held, the entire chassis with its front panel can withdrawn forward. When the chassis is inserted into the case later on, it should be noticed that the case has to fit under the flange of the front panel. The same applies for the rear of the case, on which the rear cover is put.

Caution !
During opening or closing of the case, the instrument must be disconnected from all power sources for maintenance work or a change of parts or components. If a measurement, trouble-shooting, or an adjustment is unavoidable, this work must be done by a specialist, who is familiar with the risk involved.

When the instrument is set into operation after the case has been removed, attention must be paid to the acceleration voltage for the CRT -2025V and +12kV and to the operating voltages for both final amplifier stages 115V and 66V. Potentials of these voltages are on the PS-Board, the CRT-PCB, on the upper and lower PCBs. Such potentials are moreover on the checkpoint strips on the upper and lower horizontal PCBs. They are highly dangerous and therefore precautions must be taken. It should be noted furthermore that shorts occurring on different points of the CRT high voltage and unblanking circuitry will definitely damage some semiconductors and the opto-coupler. For the same reason it is very risky to connect capacitors to these points while the instrument is on.

Capacitors in the instrument may still be charged, even when the instrument is disconnected from all voltage sources. Normally, the capacitors are discharged approx. 6 seconds after switching off. However, with a defective instrument an interruption of the load is not impossible. Therefore, after switching off, it is recommended to connect one by one all terminals of the check strips on the upper PCB across 1k Ω to ground (chassis) for a period of 1 second.

Handling of the CRT needs utmost caution. The glass bulb must not be allowed under any circumstances to come into contact with hardened tools, nor should it undergo local superheating (e.g. by soldering iron) or local undercooling (e.g. by cryogenic-spray). We recommend the wearing of safety goggles (implosion danger).

The complete instrument (with case closed and POWER button depressed) is after each intervention undergo a voltage test with 2200V, DC, between accessible parts to both mains/line supply terminals. This test is dangerous and requires an adequately trained specialist.

Operating Voltages

All operating voltages (+12V, -12V, +115V, +66V, -205V) are stabilized by the switch mode power supply. The +12V supply is further stabilized and used as a reference voltage for -12V stabilisation. These different operating voltages are fixed voltages, except the +12V, which can be adjusted. The variation of the fixed voltages greater than 5% from the nominal value indicates a fault. Measurements of the high voltage may only be accomplished by the use of a sufficient highly resistive voltmeter (>10M Ω). You must make absolutely sure that the electric strength of the voltmeter is sufficiently high. It is recommended to check the ripple and also the interaction from other possible sources. Excessive values might be very often the reason for incomprehensible faults.

Maximum and Minimum Brightness

Two variable resistors (470k Ω), located on the switch mode power supply PCB, are used for these adjustment procedures. They may only be touched by a properly insulating screwdriver (*Caution! High voltage!*). The adjustments may possibly have to be repeated, because the functions of both variable resistors are dependent on each other. Correct adjustment is achieved, when the trace can be blanked in XY mode and, in addition, when the requirement described in the Test Instructions are met.

Astigmatism control

The ratio of vertical and horizontal sharpness can be adjusted by the variable resistor of 47k Ω , located on the CRT PCB. As a precaution however, the voltage for the vertical deflecting plates (approx. +42V when the trace is in center position) should firstly be checked, because this voltage will affect the astigmatism correction. While the adjustment is being carried out (with medium brightness and a 1MHz square-wave signal), the upper horizontal square-wave tops are firstly focussed with the FOCUS control. Then the sharpness of the vertical lines are corrected with the 47k Ω Astigm. pot. The correction should be repeated several times in this sequence. The adjustment is optimised, when the FOCUS knob exclusively brings no improvement of the sharpness in both directions.

Trigger Threshold

The internal trigger threshold should be in the range 0.3 to 0.5div. display height. It is strongly dependent on the comparator IC. If there are compelling reasons to replace this comparator, it may be that triggering becomes too sensitive or too insensitive caused by the IC gain tolerances (see Test Instructions: „Triggering Checks“). In extreme cases, the hysteresis resistor of the comparator should be changed. Generally, max. halving or doubling of this resistance value should be sufficient. A too small trigger threshold cause double-triggering or premature trigger action due to interference pulses or random noise. A too high trigger threshold prevents the display of very small display heights.

Trouble-Shooting the Instrument

For this job, at least an isolating variable mains/line transformer (protection class II), a signal generator, an adequate precise multimeter, and, if possible, an oscilloscope are needed. This last item is required for complex faults, which can be traced by the display of signal or ripple voltages. As noted before, the regulated high voltage and the supply voltages for the final stages are highly dangerous. Therefore it is recommended to use totally insulated extended probe tips, when trouble-shooting the instrument. Accidental contact with dangerous voltage potentials is then unlikely. Of course, these instructions cannot thoroughly cover all kinds of faults. Some common-sense will certainly be required, when a complex fault has to be investigated.

If trouble is suspected, visually inspect the instrument thoroughly after removal of the case. Look for loose or badly contacted or discolored components (caused by overheating). Check to see that all circuit board connections are making good contact and are not shorting to an adjacent circuit. Especially inspect the connections between the PCBs, to front chassis parts, to CRT PCB, to trace rotation coil (inside of CRTs shielding), and to the control potentiometers and switches on top of and beneath the PCBs. This visual inspection can lead to success much more quickly than a systematic fault location using measuring instruments. Prior to any extensive trouble-shooting, also check the external power source.

If the instrument fails completely, the first and important step - after checking the power fuses - will be to measure the deflecting plate voltages of the CRT. In almost any case, the faulty section can be located. The sections represent:

1. Vertical deflection.
2. Horizontal deflection.
3. CRT circuit.
4. Power supply.

While the measurement takes place, the position controls of both deflection devices must be in mid-position. When the deflection devices are operating properly, the separate voltages of each plate pair are almost equal then (Y approx. **42V** and X approx **60V**). If the separate voltages of a plate pair are very different, the associated circuit must be faulty. An absent trace in spite of correct plate voltages means a fault in the CRT circuit. Missing deflection plate voltages is probably caused by a defect in the power supply.

Adjustments

As advised in the Operating, Test and Service Instructions, small corrections and adjustments are easily carried out with the aid of the Circuit Diagrams and Adjusting Plan. However, a complete recalibration of the scope should not be attempted by an inexperienced operator, but only someone with sufficient expertise. Several precision measuring instruments with cables and adapters are required, and only then should the pots and trimmers be readjusted, provided that the result of each adjustment can be exactly determined. Thus for each operating mode and switch position, a signal with the appropriate sine or square waveform, frequency, amplitude, risetime and duty cycle is required.

RS232 Interface - Remote Control

The oscilloscope is supplied with a serial interface for control purposes. The interface connector (9 pole D- SUB female) is located on the rear of the instrument. Via this bidirectional port, the instrument parameter settings can be transmitted to a PC or received from a PC. The attached disk contains example programs.

The maximum connecting cable length must not exceed 3 meters and must contain 9 lines connected 1:1.

The pin connection of the RS232 interface (9 pole D- SUB female) is determined as follows:

Pin

- 2 Tx data (data from oscilloscope to external device)
- 3 Rx data (data from external device to oscilloscope)
- 5 Ground (reference potential - connected via the oscilloscope's power cord with protective earth)

The maximum voltage swing at pin 2 resp. pin 3 is ± 12 volt. The RS232 parameter are:

N-8-2 (no parity bit, 8 data bits, 2 stop bits, XON/XOFF protocol)

Baud-Rate Setting

After the first POWER UP (switching on of the oscilloscope) and the first command CR (0D hex) sent from the PC, the baud rate is recognized and set automatically between 110 baud and 19200 baud. Then the oscilloscope transmits the RETURN CODE: 0 CR LF to the PC. The oscilloscope is then switched over to REMOTE control mode. In this status all settings (with the exception of INTENS, FOCUS, TR and CAL frequency) can be controlled by the PC only.

The only ways to quit this status are:

- Switching the oscilloscope off,
- depressing the AUTO SET (LOCAL) pushbutton or transmitting the command
- RM= 0 from the PC to the oscilloscope.

If at the beginning no CR command is recognizable, the oscilloscope pulls the TxD line low for approx. 0.2ms and causes a break on the PC.

Data Communication

After successfully being set to remote control mode, the oscilloscope is prepared for command reception. The following commands are available:

Query	?	asks for parameter
Allocation	=	sets parameter
Status	:	declares actual parameter
Binary data	[b]	data field consists of 1 byte binary data
ASCII data	[a]	data field consists of ASCII data
ASCII number	[n]	integer ASCII parameter
Binary data	[array]	data field consists of binary data
Terminator	(CR LF)	carriage return and/or line feed
Return code	[R]	ASCII parameter

Command definition

Kommand: PC→Scope	Rückgabe Scope→PC	Beschreibung
ID?	ID:Daten(CR LF)	data consists of: instrument type, manufacturer
(CR)	[R](CR LF)	remote status and baud rate acceptance
TRSTA?	TRSTA:[b](CR LF)	query for trigger status (data bit 0)
TRSTA=[b]	[R](CR LF)	reset Trigger
RM?	RM: [a](CR LF)	query for remote status
RM=[a](CR LF)	[R](CR LF)	change remote status
LK?	LK=[a](CR LF)	interlock request: LK: 1 → locked 0 → unlocked
LK=[a](CR LF)	[R](CR LF)	interlock setting for LOCAL (Auto Set) pushbutton
VER?	VER:[a](CR LF)	query for software version
HELP?	HELP: [a](CR LF)	query for command listing
DDF?	DDF:[array]	query for instrument data field
DDF=[array]	[R](CR LF)	transmits new data field to the scope
SAVEDF=[n]	[R](CR LF)	stores instrument data field in instrument memory n (1-6)
RECDF=[nl]	[R](CR LF)	recall's instrument data field from instrument memory n (1-6)
POSY 1?	POSY1: [b]	query for CH I position setting
POSY1=[b]	[R](CR LF)	sets CH I Y-position
POSY2?	POSY2: [b]	query for CH II position setting
POSY2=[b]	[R](CR LF)	sets CH II Y-position
VARY1?	VARY1: [b]	query for CH I VAR 2.5:1 setting
VARY1=[b]	[R](CR LF)	sets CH I VAR 2.5:1
VARY2?	VARY2: [b]	query for CH II VAR 2.5:1 setting
VARY2=[b]	[R](CR LF)	sets CH II VAR 2.5:1
VARTBA	VARTBV[b]	query TB1 TIME-VAR
VARTB1=[b]	[R](CR LF)	sets TBI TIME-VAR
TRLEV?	TRLEV:[b]	query for Trigger-Level
TRLEV=[b]	[R](CR LF)	sets Trigger-Level
XPOS?	XPOS:[b]	query X-Position
XPOS=[b]	[R](CR LF)	sets X-Position
CH1?	CH1:[b]	query CH I settings (deflection coefficient, INV, GD, AC/DC)
CH1=[b]	[R](CR LF)	sets CH I (deflection coefficient, INV, GD, AC/DC)
CH2?	CH2:[b]	query CH II settings (deflection coefficient, INV, GD, AC/DC)
CH2=[b]	[R](CR LF)	sets CH II (deflection coefficient, INV, GD, AC/DC)
MODE?	MODE:[b]	query for oscilloscope mode setting (Yt, XY, COMP, TESTER)
MODE=[b]	1[R](CR LF)	sets oscilloscope mode (Yt, XY, COMP, TESTER)
TB1?	TB1: [b]	query for timebase setting
TB1=[b]	[R](CR LF)	set timebase
TB2?	TB2:[b]	query for timebase setting in DELand DTR mode
TB2=[b]	[R](CR LF)	set timebase in DEL and DTR mode
TRIG?	TRIG: [b]	query for trigger parameter
TRIG=[b]	[R](CR LF)	set trigger parameter
TRVAL	TRVAL: [array]	query for signal amplitude at trigger amplifier output, INTEGER 1st word = positive peak value 2nd word = negative peak value 3rd word = peak to peak value 4th word = reference potential for positive and negative peak values Rating: approx. 20mV/LSB and 250mV/div.

Command Chart:

Commands cause the instrument to reply with parameter or a RETURN CODE transmission. You must then wait for the end of transmission before the next command is sent from

the PC to the oscilloscope, otherwise it results in a buffer overflow. The setting of the oscilloscope is made via the Instrument Data Field (Device Data Field = DDF) as a binary array. Each byte of the data field can also be called-up by a single command. The following chart shows the structure and the appertaining single commands:

Instrument Data Field with Single Commands

Kommand:	D7	D6	D5	D4	D3	D2	D1	D0
CH1	GND	AC	INV1	ON	VALUE Counter 0-13			
CH2	GND	AC	INV2	ON	VALUE Counter 0-13 mv/DIV = 0000 20V/DIV = 1101			
MODE	CT	XY	A-TR	CHOP	ADD	0	TR-SOURCE 00=Y1 01=Y2 1x=EXT	
TB1	x10	0	0	TB-A	TIME Counter 1-26 50ns/DIV = 00 bis 0,5s/DIV = 15hex			
TB2	0	DEL-MODE off = 00 SEA = 01 DEL = 10 DTR = 11		TB-B	TIME Counter 1-26 50ns/DIV = 00 bis 50ms/DIV = 12hex			
TRIG	±	0	P-P	NORM	0	COUPLING 0-6 AC=00, DC=01 HF=02, LF=03 LINE=04 TV-F =05 TV-L =06		
TRLEV			8-BIT					
VARTB1			8-BIT					
VARY2			8-BIT					
VARY1			8-BIT					
XPOS			B-BIT					
POSY2			8-BIT					
POSY1			8-BIT					

The data field is internally checked for logical errors which are protocollod in the RETURN CODE.

The following RETURN CODES are implemented:

0 = no error 1 = syntax error 2 = data error
3 = buffer overflow 4 = bad data set

Short instruction for HM604-3

Switching on and initial setting

Case, chassis and all measuring terminals are connected to the safety earth conductor (**Safety Class I**). Connect instrument to power outlet, depress red **POWER** button. LED's indicating operating condition. Instrument is set as it was before switching off. Adjust trace intensity for medium brightness. If no trace is visible, depress **AUTO SET** to switch to Yt mode. Focus trace using **FOCUS**.

Vertical amplifier mode

Channel I: If no LED lit on the **CH I VOLTS/DIV** scale, depress pushbutton **CH I**. If a LED on the **CH II VOLTS/DIV** is lit too, depress pushbutton **CH II** to switch it off.

Channel II: If no LED lit on the **CH II VOLTS/DIV** scale, depress pushbutton **CH II**. If a LED on the **CH I VOLTS/DIV** is lit too, depress pushbutton **CH I** to switch it off.

DUAL (channel I and channel II): Depress the **CH I** or **CH II** pushbutton so that a **LED** is lit on both channel I and **II VOLT/DIV** scales.

Addition (ADD): Depress both **CH I** and **CH II** pushbuttons simultaneously until the **ADD LED** lights.

Addition (sum): With both input signals in phase switch both **INV LED's** on or both off.

Addition (difference): With both input signals in phase switch only one **INV LED** on.

Addition mode can be exited by depressing both **CH I** and **CH II** pushbuttons simultaneously until the **ADD LED** is dark.

Triggering mode

Select trigger mode by depressing both **NORM** pushbuttons simultaneously:

NM LED dark = automatic peak (value) triggering < 20 Hz - 100 MHz. **TRIG. LEVEL** active.

NM LED lit = normal triggering. **TRIG. LEVEL** active.

Trigger edge direction: select with \pm pushbutton. **- LED** lit = falling slope, dark = rising slope.

Internal triggering: In **CH I** and **CH II** mode automatically set and indicated by **TR I** and **TR II LED's**.

In **DUAL** and **ADD** mode briefly depress the **TRIG.** pushbutton for switching over.

Internal alternate triggering: In **DUAL** mode depress and hold the **TRIG.** pushbutton until both **TR I** and **TR II** are lit.

Switch off this mode by briefly depressing the **TRIG.** pushbutton.

External triggering: Depress the **EXT** pushbutton next to the **TRIG. INP. BNC** socket to light the **EXT LED**.

Trigger Signal 0.3Vpp - 3Vpp at **TRIG. INP.** Return to internal triggering by depressing the **EXT.** pushbutton again (**EXT LED** dark).

Line triggering: Select the \sim symbol on the trigger coupling scale depressing one of the **NORM** pushbuttons (**up / down**).

Trigger coupling: Choose **AC/DC/HF/LF/TV-L/TV-F** by depressing one of the **NORM** pushbuttons.

Frequency ranges: **AC** 10 Hz - 100 MHz; **DC** 0 Hz - 100MHz; **HF** 1.5kHz - 100 MHz; **LF** 0 Hz - 1.5 kHz.

TV-L to trigger on line sync. pulses; **TV-F** to trigger on separated frame sync. pulses. Select \pm (**SLOPE**) for the leading slope. Sync pulse above picture content = + (- LED dark), below = - (- LED lit).

Pay attention to trigger indicator: **LED** above **TRIG.**

Measurements

Apply test signal(s) to the vertical input connectors of **CH I** and/or **CH II**.

Before use, compensate attenuator probe with built-in square wave generator **CAL**.

Depress **AUTO SET** for automatic instrument set up or:

Select **AC** or **DC** (**LED** lit) input coupling (**GD LED** dark).

Adjust signal to desired display height with $< >$ arrow pushbutton(s) in **VOLTS/DIV.** sector.

Amplitude measurement with Y fine control (**VAR. 2.5:1**) at right stop.

Adjust signal to desired number of displayed periods with $< >$ arrow pushbutton(s) in **TIME/DIV.** sector.

Time measurement with time fine control (**VAR. 2.5:1**) at right stop.

Time expansion with **x10 LED** lit.

Set trigger point with **TRIG. LEVEL** knob in automatic peak (value) and normal (**NM LED** lit) triggering.

Select automatic peak (value) or normal triggering by depressing both **NORM** pushbuttons simultaneously.

Improve complex or aperiodic signal stability with longer **HOLD OFF**-time or in **DELAY** mode (**DEL** or **DTR**).

For the expansion of signal portions, use delay (**DEL**) or after delay trigger mode (**DTR**) with reduced time coefficient (**TIME/DIV**).

Normal undelayed mode = no **DELAY LED (SEA/DEL/DTR)** lights.

Depress **DELAY** pushbutton once (**SEA** - search - **LED** lights) and adjust the timebase start position using **DEL. POS.** knob and **TIME/DIV** $< >$ pushbutton(s).

Briefly depress **DELAY** pushbutton to switch over to delay mode (**DEL** lights). Now the timebase starts (**DEL** lit) with the selected start point and the trace length has full length. For start point and expansion rate corrections use **DEL. POS.** and **TIME/DIV** settings.

Depressing the **DELAY** pushbutton once again switches over to triggered delay mode (**DTR** lights) and automatically to **DC** trigger coupling (**DC LED** on **TRIG** scale lights) and normal triggering (**NM LED** lights).

\pm (**SLOPE**) and **TRIG. LEVEL** are active and set in their previously used settings.

Depress the **DELAY** pushbutton again to switch to normal mode. Then all **LED's** on the **DELAY** scale are dark.

SEA and **DEL** can be exited without stepping through the modes by depressing and holding the **DELAY** pushbutton until all **LED's** are dark.

Component tester mode

Depress **COMP. TESTER** pushbutton.

COMP. TESTER mode is active if all **LED's** are dark (exception **X MAG. x10**).

In-circuit-test: Circuit under test must be disconnected from battery or power (pull out power plug), signals and ground (earth). Remove all signal connections to the instrument (cable, probe), then start testing.

Front Panel Elements HM 604-3 (Brief Description - Front View)

Element	Function	Element	Function
① POWER (pushbutton)	Turns scope on and off. I = ON; O = OFF	⑱ Trigger Coupling (LED scale)	Indicates trigger coupling: AC: <20Hz - 100MHz DC: 0 - 100MHz HF: 1.5kHz - 100MHz LF: 0 - 1.5kHz ~ : Internal line triggering TV-L: Triggering for TV-line TV-F: Triggering for TV-frame. Selectable by NORM buttons (22).
② FOCUS (knob)	Focus control for trace sharpness (mechanical).	⑲ +/- (SLOPE) (pushbutton + LED)	Selects the slope of the trigger signal. LED dark = rising edge. LED lit (-) = falling edge.
③ TR	Trace rotation (mechanical). To align trace with horizontal field.(potentiometer; graticule line. Compensates adjustment with influence of Earth's magnetic screwdriver)	⑳ TRIG. LEVEL (knob)	Adjustment of trigger level (knob) in automatic peak (value) and normal triggering.
④ INTENS. (knob)	Intensity control for trace brightness. (mechanical)	㉑ DEL. POS. HOLD OFF (knob)	Controls holdoff-time between sweeps. Normal HOLD OFF position = full ccw (x1). In DELAY mode for delay time adjustment; hold off defaults to x1.
⑤ X-POS. (knob)	Controls horizontal position of trace.	㉒ NORM (pushbuttons + „NM“ LED)	Depressing both pushbuttons simultaneously switches over from automatic peak (value) triggering (NM LED dark) to normal triggering (NM LED lit) and reverse.
⑥ AUTO SET (pushbutton) (RS232/Local)	Automatic signal related instrument setting. If in XY or COMP. TESTER mode, the instrument switches over to Yt (DUAL or MONO) mode. The electrical settings are taken over independent from the mechanical knob settings. Turning the knob reverts to the actual mechanical knob setting.	㉓ CAL. 1kHz/1MHz (pushbutton switch)	Selects calibrator frequency. Button released: approx. 1kHz, Button depressed: approx. 1MHz. (mechanical)
⑦ X-MAG. x10 (pushbutton + LED)	10:1 expansion in the X direction (LED lit). direction (LED lit). Max. resolution 5ns/div.	㉔ 0.2Vpp - 2Vpp (test sockets)	Calibrator square wave output, 0,2Vpp or 2Vpp.
⑧ XY (pushbutton + LED (15))	Selects X-Y operation, stops sweep and reverse. X signal via CH. II. Caution! Phosphor burn-in without X signal.	㉕ COMP. TESTER (4mm jacks)	Connectors for test leads of the Component tester.
⑨ DELAY (pushbutton)	Selects DELAY mode and reverse. SEA = search, DEL= delay and DTR = after delay trigger. Delay time settig by DEL. POS. (21) and time coefficient (TIME/DIV. (12)).	㉖ COMP. TESTER (pushbutton)	Switch to convert oscilloscope from Yt or XY to component tester mode and reverse.
⑩ DELAY (LED scale)	Indicates the delay mode. Dark = off, SEA = select delay time, DEL = delayed display and DTR = triggered display after delay.	㉗ Y-POS.I (knob)	Controls vertical position of channel I display.
⑪ SAVE/RECALL (pushbutton)	Briefly depressing calls the set-up memories; LED(18) blinks. Memory location selection (S/R scale (16)) by NORM buttons (22). Briefly press SAVE/RECALL for RECALL. Press SAVE/RECALL until LED stops blinking to SAVE.	㉘ INV (pushbutton + LED)	Inversion of CH. I display (INV LED lit) and reverse. In combination with ADD button = difference CH. II CH. I.
⑫ TIME/DIV. (<> pushbuttons)	Selects time coefficients of timebase, from 0.5s/div. to 0.05µs/div. < pushbutton increases > pushbutton decreases time coefficient. In SEA (search) DELAY mode, selects for coarse setting of delay time.	㉙ INPUT CH I (BNC connector)	Channel I signal input. Input impedance 1MΩ 20pF.
⑬ TIME/DIV. (LED scale)	Indicates time coefficient. Blinking indicates uncalibrated setting of (14). In seconds ranges the sec LED is also lit.	㉚ AC-DC (pushbutton + „DC“ LED)	Selects input coupling of CH. I vertical amplifier. DC = direct coupling (LED lit) AC = coupling via capacitor (LED dark).
⑭ VAR. 2.5:1	Variable adjustment of (knob) timebase. Decreases X deflection speed at least 2.5 fold at left stop. For time measurements turn to right hand stop.	㉛ GD (pushbutton + LED)	GD (LED lit) = signal disconnected from input, Y amplifier input grounded.
⑮ XY (LED)	Indicates XY mode. Dark in Yt (LED) and COMP. TESTER mode.	㉜ VOLTS/DIV. (pushbuttons LED scale)	Channel I input attenuator. <> pushbuttons select Y input sensitivity in mV/div. or V/div. in 1-2-5 sequence. Deflection coefficient LED blinking = uncalibrated.
⑯ S/R 1-6 (scale)	Memory location indicator. Blinking indicates SAVE/RECALL (scale) mode and memory location.	㉝ VAR. 2.5:1 (knob)	Fine adjustment of Y amplitude CH. I. Increases attenuation factor min. by 2.5 (left hand stop). For amplitude measurement must be in CAL. position (right hand stop).
⑰ TRIG.	LED above indicates trigger (LED) action (sweep triggered).		

Element	Function	Element	Function
34 CH I & CH II (pushbuttons + „ADD“ LED)	Pushbuttons for Mono CH I and CH II, DUAL and ADD selection. Mode indication by LED(s) deflection coefficient coefficient scale. In Yt mode at least one LED on a scale lit. To switch over to the other channel activate that channel (pressing CH I or CH II) causing DUAL mode. Then switch off the previous channel by depressing the respective channel pushbutton. In combination with internal triggering the triggersource follows the mono channel setting. For algebr. addition depress CH and CH II simultaneously (ADD LED lit). Depressing both pushbuttons simultaneously again reverts to the previous setting.	38 GD (pushbutton + LED)	GD (LED lit) = signal disconnected from input, Y amplifier input grounded.
35 TRIG. (pushbutton + LED's)	Triggersource selection in internal trigger mode. Depressing in DUAL mode causes the switch over from trigger source channel I (TR I) to trigger source channel II (TR II) and reverse. Depressing the pushbutton until both TR I and TR II LED's lit, switches over to alternate triggering if DUAL mode is active. Depress again to quit alternate triggering. Not available in combination with ext. triggering, XY or COMP. TESTER modes.	39 VOLTS/DIV. (pushbuttons + LED scale)	Channel II input attenuator. <-> pushbuttons select Y input sensitivity in mV/div. or V/div. in 1-2-5 sequence. Deflection coefficient LED blinking = uncalibrated.
36 INPUT CH II (BNC connector)	Channel II signal input. Input impedance 1MΩ II 20pF.	40 VAR. 2.5:1 (knob)	Fine adjustment of Y amplitude (knob) CH.II. Increases attenuation factor min. by 2.5 (left hand stop). For amplitude measurement must be in CAL. position (right hand stop).
37 AC-DC (pushbutton + „DC“ LED)	Selects input coupling of CH. II vertical amplifier. DC = direct coupling (LED lit) AC = coupling via capacitor (LED dark).	41 EXT (pushbutton +LED)	Pushbutton selects between internal and external trigger source. If the EXT LED lights the trigger signal originates from the TRIG. INP. socket (44).
		42 Y-POS.II (knob)	Controls vertical position of channel II display.
		43 INV (pushbutton +LED)	Inversion of CH. II (display LED lit) and reverse. In combination with ADD button = difference CH. II CH. I.
		44 TRIG. INP. (BNC-connector)	External triggersignal input. Active if the EXT LED lit.

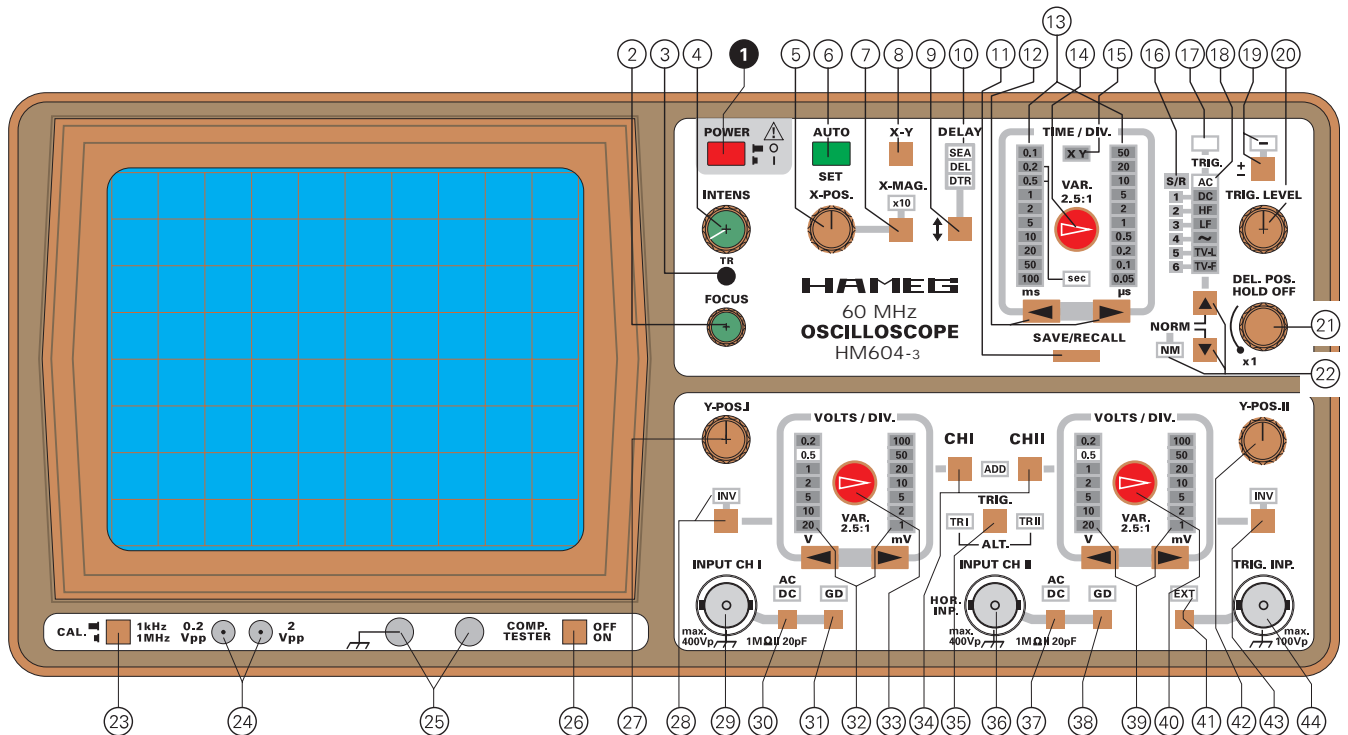

HAMEG[®]

Instruments

Oscilloscopes
Multimeters
Counters
Frequency
Synthesizers
Generators
R- and LC-
Meters
Spectrum
Analyzers
Power Supplies
Curve Tracers
Time Standards

Germany

HAMEG GmbH

Kelsterbacher Str. 15-19
60528 FRANKFURT am Main
Tel. (069) 67805 0
Telefax (069) 6780513

France

HAMEG S.a.r.l

5-9, av. de la République
94800-VILLEJUIF
Tél. (1) 4677 8151
Telefax (1) 4726 3544

Spain

HAMEG S.L.

Villarroel 172-174
08036 BARCELONA
Teléf. (9) 3 4301597
Telefax (9) 3 3212201

Great Britain

HAMEG LTD

74-78 Collingdon Street
LUTON Bedfordshire LU1 1RX
Phone (01582)413174
Telefax (01582)456416

United States of America

HAMEG, Inc.

1939 Plaza Real
OCEANSIDE, CA 92056
Phone (619) 630 4080
Telefax (619) 630 6507

HAMEG, Inc.

266 East Meadow Avenue
EAST MEADOW, NY 11554
Phone (516) 794 4080
Toll-free (800) 247 1241
Telefax (516) 794 1855

Hong Kong

HAMEG LTD

Flat 1, 4/F.
Crown Industrial Building
106 How Ming St., Kwun Tong
Kowloon, Hong Kong
Phone (852) 2 793 0218
Telefax (852) 2 763 5236